

WINC-G - Serisi Dönmez Kompakt Silindirler / WINC-G - Series Non-Rotating Compact Cylinders

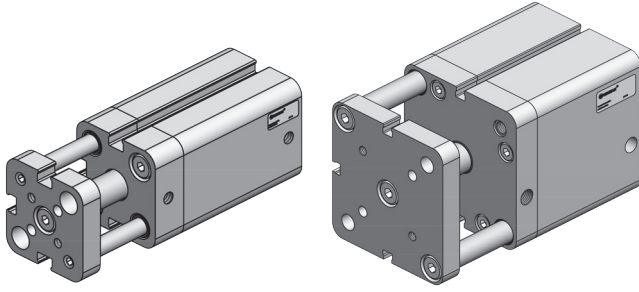

Özellikler / Specification

Piston Çapı / Bore Size	20	25	32	40	50	63
Çalışma Tipi / Acting Type	Çift Etkili / Double Acting					
Akışkan / Fluid	Hava (40µm filtrelenmiş) / Air (40µm filtered)					
Çalışma Basıncı / Op. Pressure	< 10 Bar					
Sıcaklık / Temperature	0 ~ +80 °C					
Manyetik / Magnetic	Opsiyonel / Optional					
Yastıklama Tipi / Cush. Type	Damper / Bumper					
Hız / Speed Range	< 500 mm/s					
Sensör / Sensör Switches	WT-40					

Teknik Çizim / Technical Drawing

WINC-G.020/025

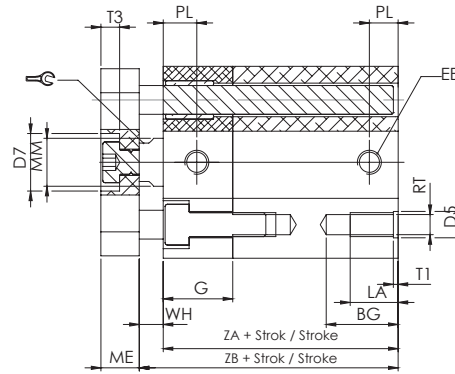
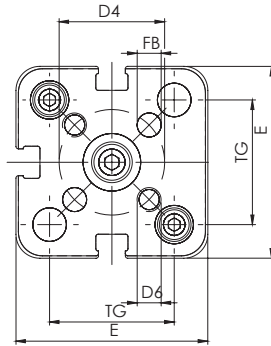

WINC-G.032/063

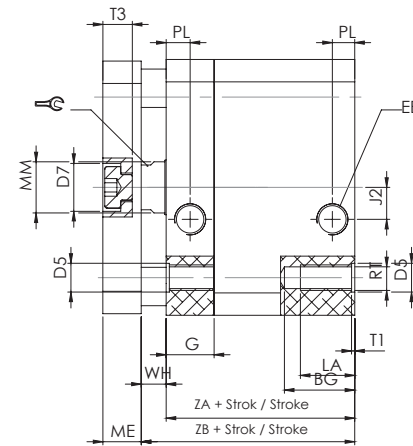
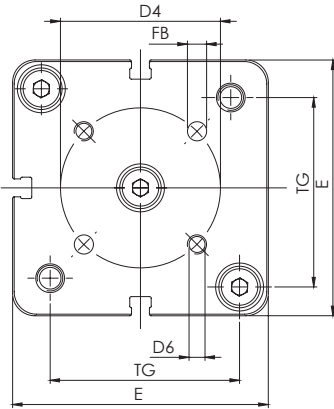

Ø mm	BG min.	D4 ±0.1	D5 Ø	D6	D7 Ø	E	EE	FB Ø h8	G	J2	LA +0.2	ME	MM Ø	PL	RT	h13	T1 +0.1	TG ±0.2	WH ±1.3	ZA ±0.3	ZB +1.2	STANDART KURSLAR
20	16.0	17	5.5	M4	10	36	M5	4	13.0	-	10.0	8	10	5.0	M5	8	1	22.0	4.5	37	49.5	10 - 20 - 25 30 - 40 - 50
25	16.0	22	5.5	M5	10	40	M5	5	14.5	-	10.0	8	10	5.0	M5	8	1	26.0	5.0	39	52.0	
32	18.0	28	6.5	M5	11	50	G1/8"	5	15.0	8	12.0	10	12	7.5	M6	10	1	32.5	6.0	44	60.0	
40	19.5	33	7.0	M5	11	58	G1/8"	5	15.0	3	12.0	10	12	7.5	M6	10	1	38.0	5.5	45	60.5	
50	22.0	42	9.0	M6	15	67	G1/8"	6	15.0	7	16.0	15	16	7.5	M8	14	1	46.5	5.2	45	65.2	
63	22.0	50	9.0	M6	15	80	G1/8"	6	15.0	10	16.0	12	16	7.5	M8	14	1	56.5	7.8	49	68.8	

Sipariş Kodu / Ordering Code

MODEL MODEL	ÇAP DIA.	STROK STROKE
WINC-G	032	0050
DÖNMEZ KOMPAKT Non-Rotating Compact	PİSTON ÇAPI (mm) Piston Dia	STROK (mm) Stroke