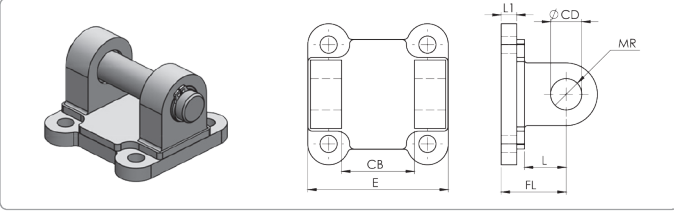
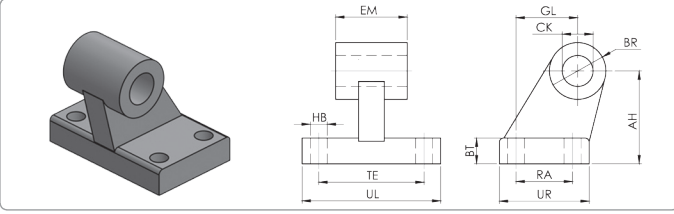

ISO 15552 Aksesuarları / ISO 15552 Accessories

WEB - Eklem Bağlantı / WEB Swivel Flange

Ø mm	CB	CD	E	FL	L	L1
32	26	10	45	22	13	9
40	28	12	52	25	16	9
50	32	12	60	27	16	11
63	40	16	70	32	21	11
80	50	16	90	36	22	14
100	60	20	110	41	27	14
125	70	25	130	50	35	15

WYB - Yer Bağlantı / WYB Clevis Foot Mounting

Ø mm	AH	BR	BT	CK	EM	GL	HB	RA	TE	UL
32	32	10	8	10	26	21	6.5	18	38	51
40	36	11	10	12	28	24	6.5	22	41	54
50	45	13	12	12	32	33	9	30	50	65
63	50	15	12	16	40	37	9	30	50	65
80	63	15	14	16	50	47	11	40	66	86
100	71	19	15	20	60	55	11	50	76	96
125	90	22	20	25	70	70	14	60	94	124

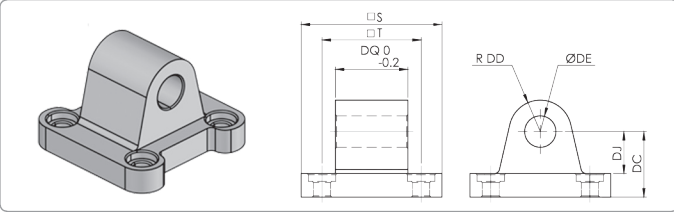
CA1 - Yer Bağlantı / CA1 Clevis Foot Mounting

Ø mm	S	T	DC	DD	DE	DJ	DQ
32	47	32,5	22	9	10	13	25,8
40	52	38	25	10,5	12	16	27,8
50	64	46,5	27	11	12	17	31,7
63	74	56,5	32	13,5	16	22	39,7
80	94	72	36	14,5	16	22	49,7
100	113	89	41	17	20	27	59,7
125	139	110	50	22	25	33	69,7
160	180	140	55	30	30	35,5	89,7
200	220	175	60	30	30	37	89,7

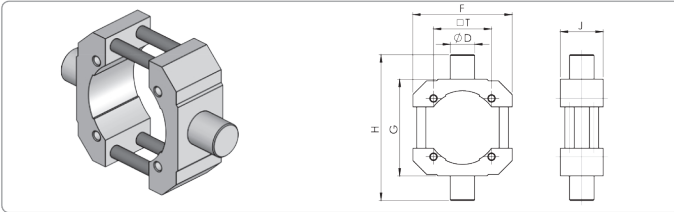
TC - Orta Mafsal Bağlantı / TC - Turnion Mounting

Ø mm	D	F	G	H	J	T
32	12	52	50	74	22	32,5
40	16	65	63	95	28	38
50	16	75	75	107	28	46,5
63	20	90	90	130	30	56,5
80	20	112	110	150	32	72
100	25	135	132	182	38	89
125	25	170	160	210	40	110
160	32	210	200	264	50	140
200	32	255	250	314	50	175

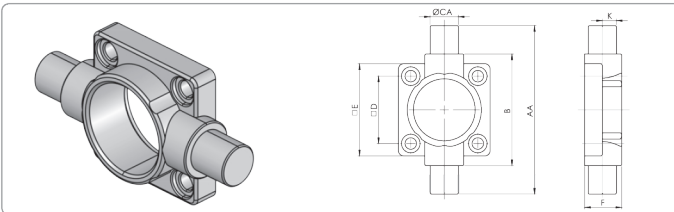
FTC - Döner Flaş / FTC - Turnion Flange

Ø mm	AA	B	CA	D	E	F	K
32	74	50	12	32,5	46	19	10
40	95	63	16	38	52	21	10
50	107	75	16	6,5	64	26	12
63	130	90	20	56,5	74	28	12
80	150	110	20	72	94	31	16
100	182	132	25	89	114	35	16
125	210	160	25	110	139	43	20
160	164	200	32	140	179	56	20
200	314	250	32	175	218	64	20

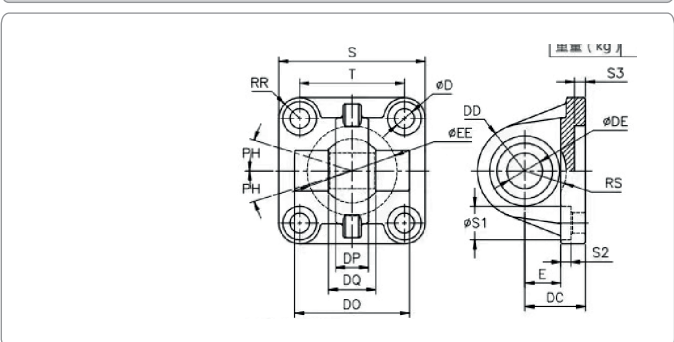
WCA-CU-Yer Bağlantı/WCA-CU-Ground Connection

Ø mm	S	T	RR	DD	DO	DP	DQ	D
32	45	32,5	6,25	16	/	10	14	6,8
40	52	38	7	18,5	/	12	16	6,8
50	65	46,5	9,25	21	51	15	21	8,8
63	75	56,5	9,25	23	/	15	21	8,8
80	95	72	11,5	28	73	18	25	11
100	115	89	11,5	30	/	18	25	11
125	140	110	15	40	140	25	37	13

Ø mm	EE	DC	DE	E	S1	S2	S3	RS	PH
32	30,5	22±0,2	10	13	/	3,5	5	/	15
40	35	25±0,2	12	16	11	3,5	5	/	15
50	40	27±0,2	16	16	15	4,5	5	18,5	15
63	45	32±0,2	16	21	15	4,5	5	/	15
80	45	36±0,2	20	22	18	4	5	24	15
100	55	41±0,2	20	27	18	4	5	/	15
125	61	50±0,2	30	30	20	10	7	78	15

ISO 15552 Aksesuarları / ISO 15552 Accessories

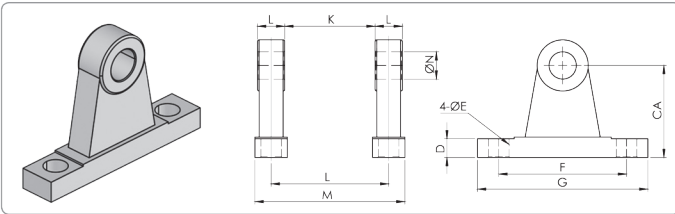
TCM1 - Döner Flaş / TCM1 - Swivel Flange

Ø mm	CA	D	E	F	G	I	K	L	M	N
32	40	11	9	60	80	12	50	62	77	12
40	54	11	12	75	100	16	63	79	98	16
50	54	11	12	75	100	16	75	91	110	16
63	70	11	12	85	110	20	90	110	133	20
80	70	11	12	85	110	20	110	130	153	20
100	90	19	18	115	155	25	132	157	185	25
125	90	19	18	115	155	25	160	185	213	25
160	10	24	22	140	190	32	200	232	267	32
200	135	27	22	150	200	32	250	282	317	32

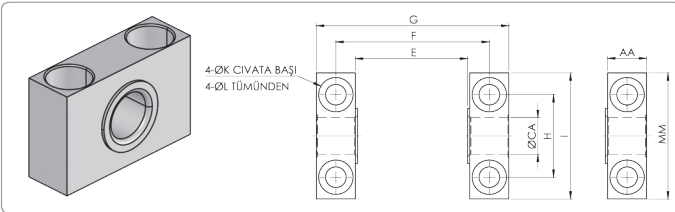
TCM2 - Döner Flaş / TCM2 - Swivel Flange

Ø mm	CA	AA	E	F	G	H	I	K	L	M
32	12	14	50	66	80	32	46	11	7	30
40	16	17	63	82	99	36	55	15	9	36
50	16	17	75	94	111	36	55	15	9	36
63	20	20,5	90	113,5	134	42	65	18	11	40
80	20	20,5	110	133,5	154	42	65	18	11	40
100	25	24,5	132	159,5	184	50	75	20	14	50
125	25	24,5	160	187,5	212	50	75	20	14	50
160	32	30	200	234	264	60	92	26	18	60
200	32	30	250	284	314	60	92	26	18	60

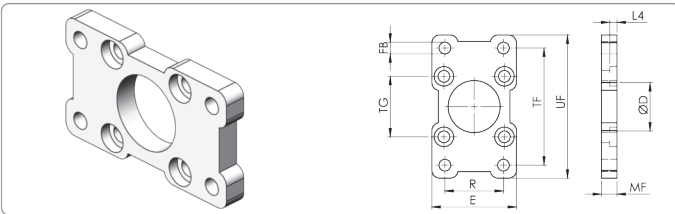
WFB - Flaş Bağlantı / WFB - Flange Mounting

Ø mm	D	E	FB	L4	MF	R	TF	TG	UF
32	30	45	7	5	10	32	64	32,5	80
40	35	54	9	5	10	36	72	38	90
50	40	65	9	6,5	12	45	90	46,5	110
63	45	76	9	6,5	12	50	100	56,5	120
80	45	94	12	9	16	63	126	72	150
100	55	112	14	9	16	75	150	89	175
125	60	135	16	10,5	20	90	180	110	210

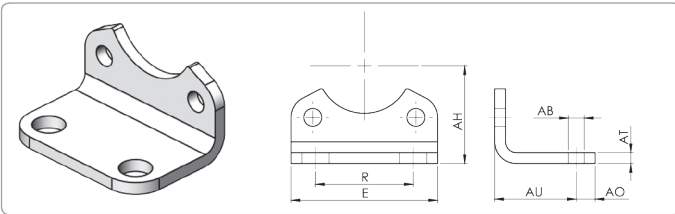
WAB - Ayak Bağlantı / WAB - Foot Mounting

Ø mm	AB	AH	AO	AT	AU	E	R
32	7	32	8	5	24	45,5	32
40	10	36	9	5	28	54,5	36
50	10	45	9	6	32	65	45
63	10	50	12	6	32	76	50
80	12	63	15	6	41	94	63
100	14	71	17	6	41	112	75
125	16	90	22	8	45	131	90

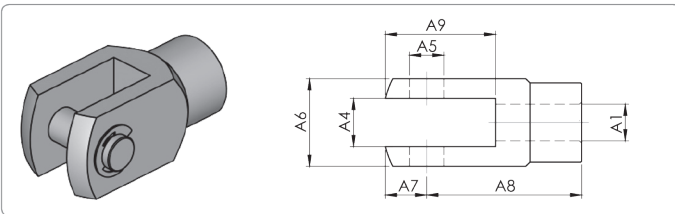
WCB - Çatal Bağlantı / WCB - Rod Clevis

Ø mm	A1	A4	A5	A6	A7	A8	A9
32	M10X1,25	10	10	20	12	40	32
40	M12X1,25	12	12	24	14	48	38
50	M16X1,5	16	16	32	19	64	51
63	M16X1,5	16	16	32	19	64	51
80	M20X1,5	20	20	40	25	80	65
100	M20X1,5	20	20	40	25	80	65
125	M27X2,0	25	25	50	38	110	92

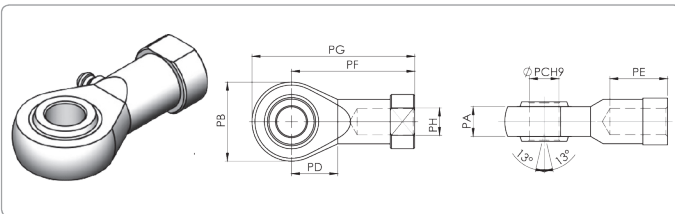
WGM - Göz Mafsal / WGM - Rod-eye Joint

Ø mm	PA	PB	PC	PD	PE	PF	PG	PH
32	14	28	10	26	20	43	57	M10X1,25
40	16	32	12	30	22	50	66	M12X1,25
50	21	42	16	39	28	64	85	M16X1,5
63	21	42	16	39	28	64	85	M16X1,5
80	25	50	20	46	33	77	102	M20X1,5
100	25	50	20	46	33	77	102	M20X1,5
125	37	70	30	64	51	110	145	M27X2,00

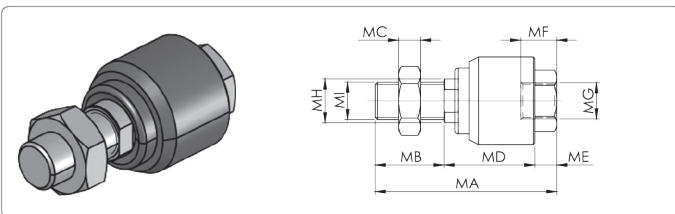
WKA - Kasıntı Alıcı / WKA - Float Connect

Ø mm	MA	MB	MC	MD	MF	MG	MH	M1
32	61,5	21	5,5	33	15	M10X1,25	10	M10X1,25
40	67,5	22	7	37	17	M12X1,25	12	M12X1,25
50	90	28	8	50	24	M16X1,5	17	M16X1,5
63	90	28	8	50	24	M20X1,5	17	M20X1,5
80	102	31	9	57	29	M20X1,5	22	M20X1,5
100	102	31	9	57	29	M20X1,5	22	M20X1,5
125	123	40	12	67,5	34	M27X2,0	30	M27X2,0