

WINMAN 2 Parçalı ISO 5211, Paslanmaz Küresel Vana / 2PC High Platform Ball Valve



WKV-11-2

Özellikler / Features

Thread Standard	NPT	BSPT	DIN259	DIN2999	ISO228 CLASS A
Max. Pressure	6.4MPa				
Temperature Range	-20°C~232°C				
Suitable Medium	Water,oilair And Some Corrosive Liquids				
Blow-out Proof stem	Full Port				
Investment Casting Body					
1000PSI(PN64)W.O.G					
Material Standard	S45C/ASTM A216Gr WCB/DIN1.00619	SS316/ASTM A351Gr CF8M/DIN1.4408	SS304/ASTM A351Gr CF8/DIN1.4308		

Teknik Çizim / Technical Drawing

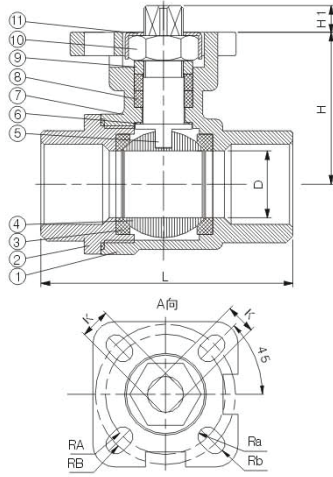

Ana Parçalar ve Malzemeler / Main Parts and Materials

1	Body	WCB/CF8M/CF8
2	Cap	WCB/CF8M/CF8
3	Seat	PTFE
4	Ball	SS316/SS304
5	Stem	SS3016/SS304/SS
6	Thrust Washer	PTFE
7	Gasket	PTFE
8	Packing	PTFE
9	Gland	SS304/SS
10	Stud Bolt	SS304/SS
11	Block Only Retreat	SS304/SS

Teknik Özellikler / Main Outer Size

NPS	DN	D	L	H	H1	RA	RB	Ra	Rb	K	Actuator
1/2"	15	15	62	38	9	18	21	3.0	3.0	9	WPNA 052DA
3/4"	20	20	75	41	9	18	21	3.0	3.0	9	WPNA 052DA
1"	25	25	76	58	11	21	25	3.0	3.5	11	WPNA 052DA
1 1/4"	32	30	91	60	11	21	25	3.0	3.5	11	WPNA 063DA
1 1/2"	40	38	105	75	14	25	35	3.5	4.5	14	WPNA 070DA
2"	50	49	120	80	14	25	35	3.5	4.5	14	WPNA 080DA