

2 MF

İki Yönlü Dişli Motor / 2MF Bi-Direction Gear Motor

Sipariş Kodu / Ordering Code

Şaft ve flanş kombinasyonları / Shaft extension and flange combination
Z03:1:8 Şaft + Avrupa Dikdörtgen Flanş / Z03: 1:8 shaft - Europe rectangle flange:

Direnaj tipi / Mode of drain:
I: İçten drenajlı / Inner drain
Boş / Omit
Dıştan drenajlı / Outside drain

Dönüş yönü / Rotation direction:
B: İki yöne / Bi-direction
L: Sol / CCW
R: Sağ / CW

Giriş / Çıkış kombinasyonu / Inlet / outlet combination
F85: inlet=ø35/M6/ø15: outlet=ø35/M6/ø15

2 A M F 8 F85 Z03 B SS - 0 - 1

Giriş / Çıkış kombinasyonu / Inlet / out position combination
SS - Yan giriş ve yan çıkış / Side inlet and side out

Motor deplasmanı / Motor displacement
 4/6/8/10/12/14/16/18/20/23/25

F: Sürekli çalışma basıncı / Continuous work pressure:200 bar

M: Dişli motor / Gear motor

A: Döküm kapak / Cast iron cover
Boş / Omit: Alüminyum kapak / Aluminum cover

O: Dıştan rulmanlı / Outboard bearing
Boş / Omit: rulmansız / Without outboard bearing

2: Grup 2 / Group 2



iki Yönlü Dişli Motor / 2MF Bi-Direction Gear Motor

Tip / Type: 2MFF**Z03B**

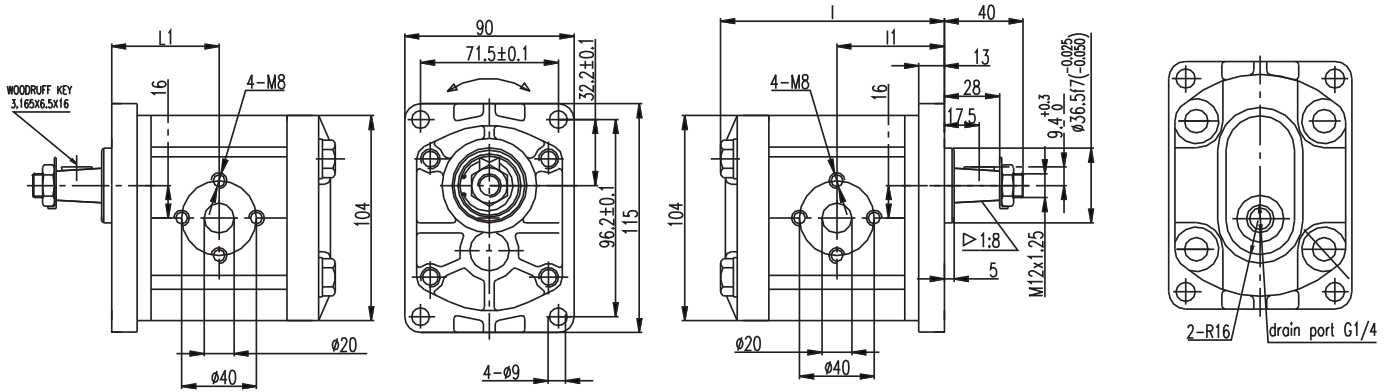

DISPLACEMENT (ml/r)	4	6	8	10	12	14	16	18	20	23	25
L1	46	47	49	50	52	53	55	57	58	60	62
L	98	100	104	106	110	112	116	119	122	125	130



iki Yönlü Dıştan Yataklı Dişli Motor / 2MF -B-0 Gear Motor With Outboard Bearing

Dıştan Yataklı / Outboard Bearing: 2MFF**Z**B-0**

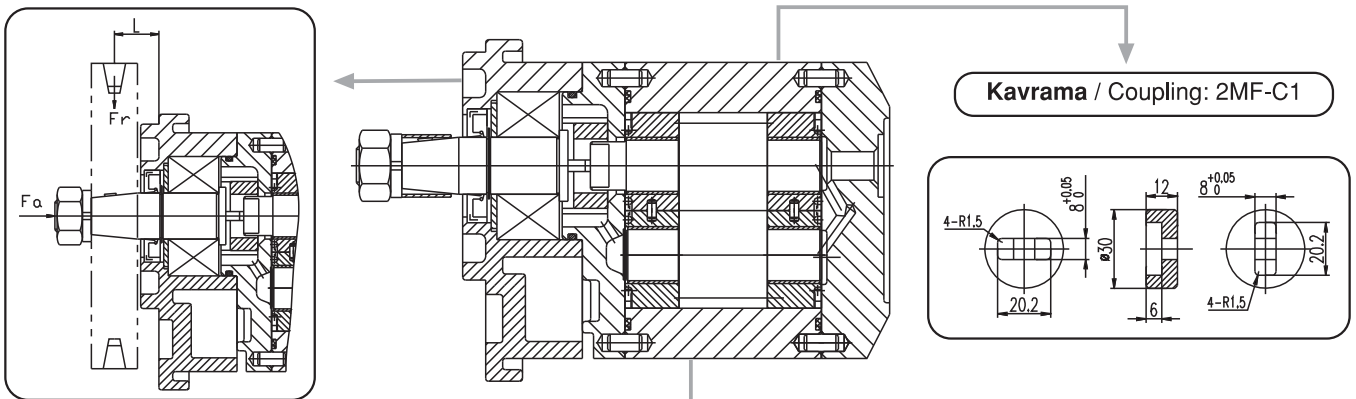

Tip / Type: 2MFF**B11B**

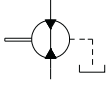

2 MF

İki Yönlü Dişli Motor / 2MF Bi-Direction Gear Motor

İzin Verilebilen Yük ve Çıkış Değerleri Tablosu / Permissible Load Of Outboard Bearing

FO=0N

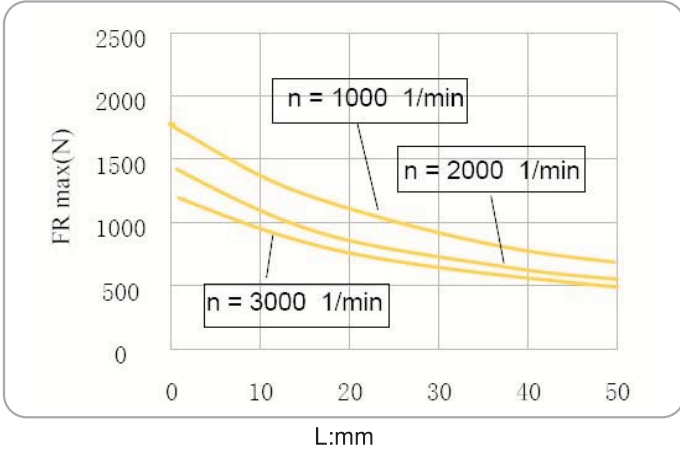

FO=200N

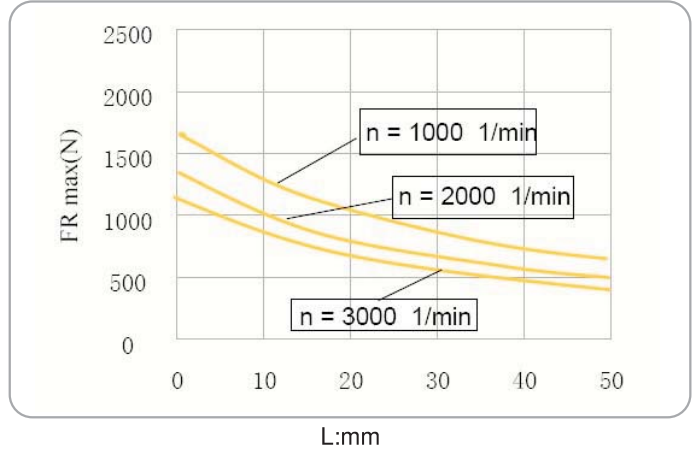

FO=400N

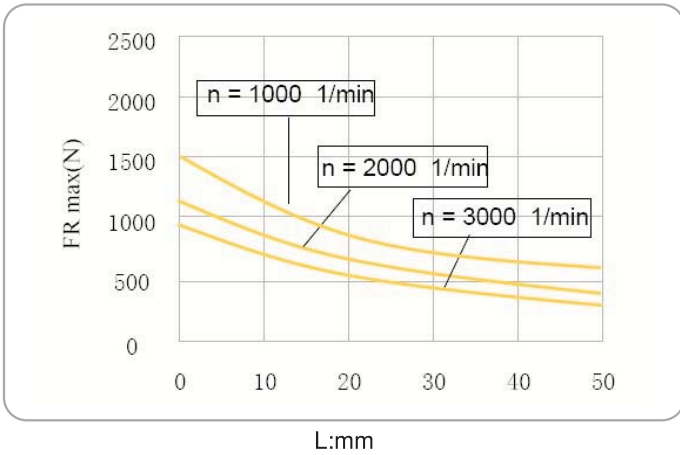

FO=600N

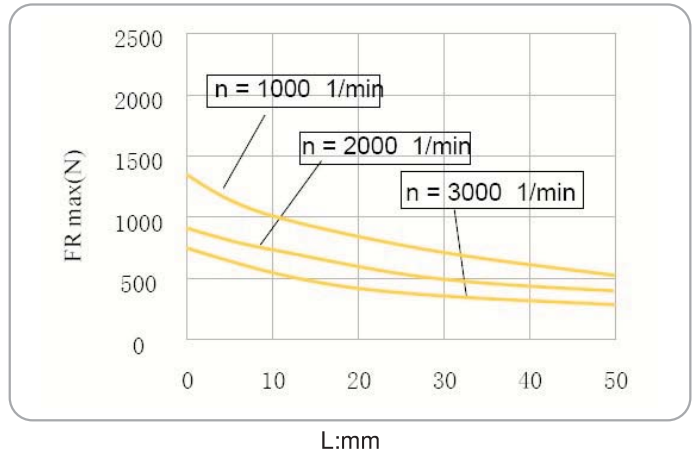

FO=800N

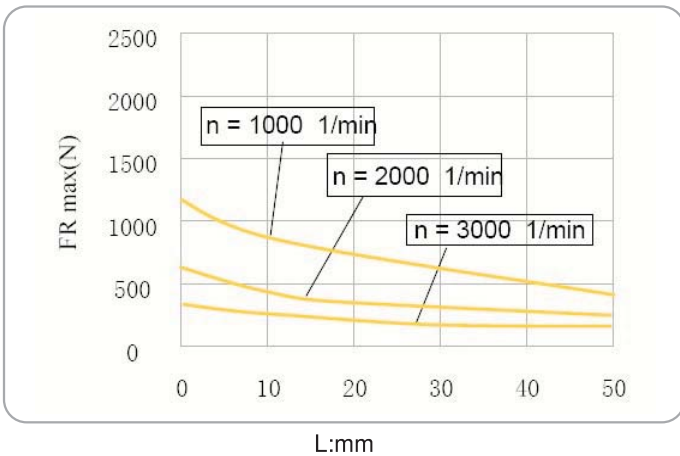

FO=900N

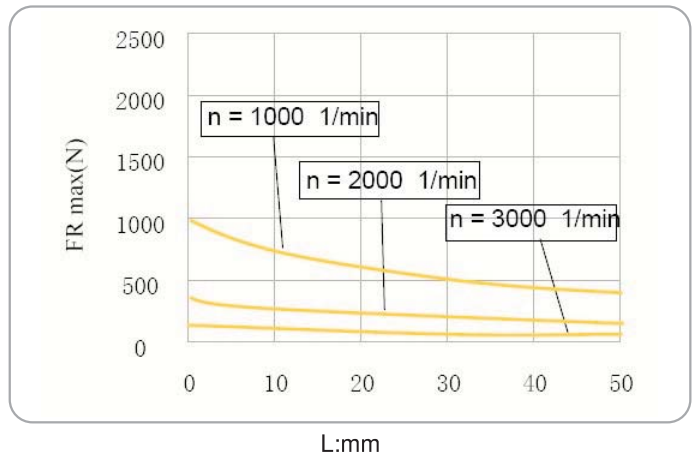

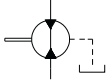

2 MF

İki Yönlü Dişli Motor / 2MF Bi-Direction Gear Motor

2MF6 Karakteristik Tablosu / Charactenstic Curves Of 2MF6

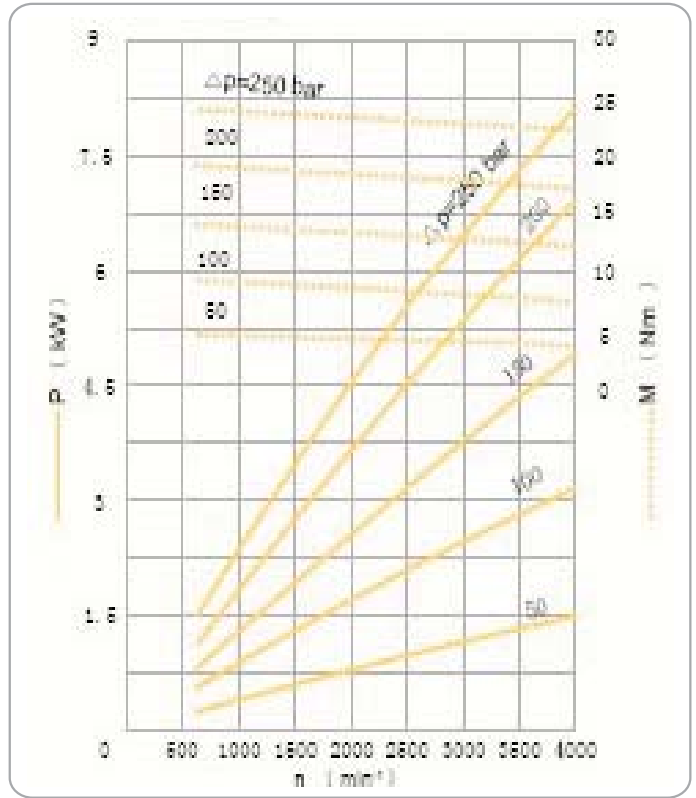
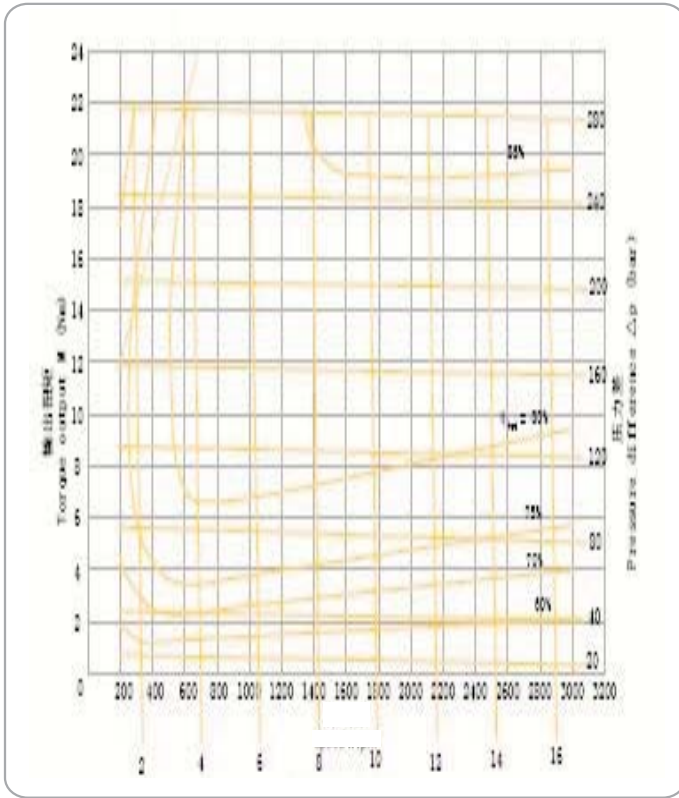

2MF8 Karakteristik Tablosu / Charactenstic Curves Of 2MF8

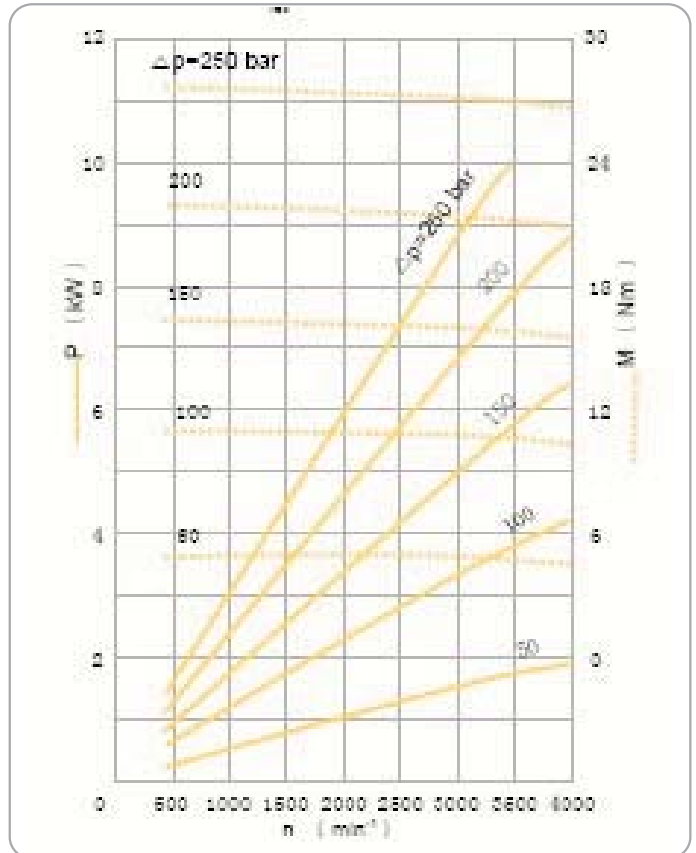
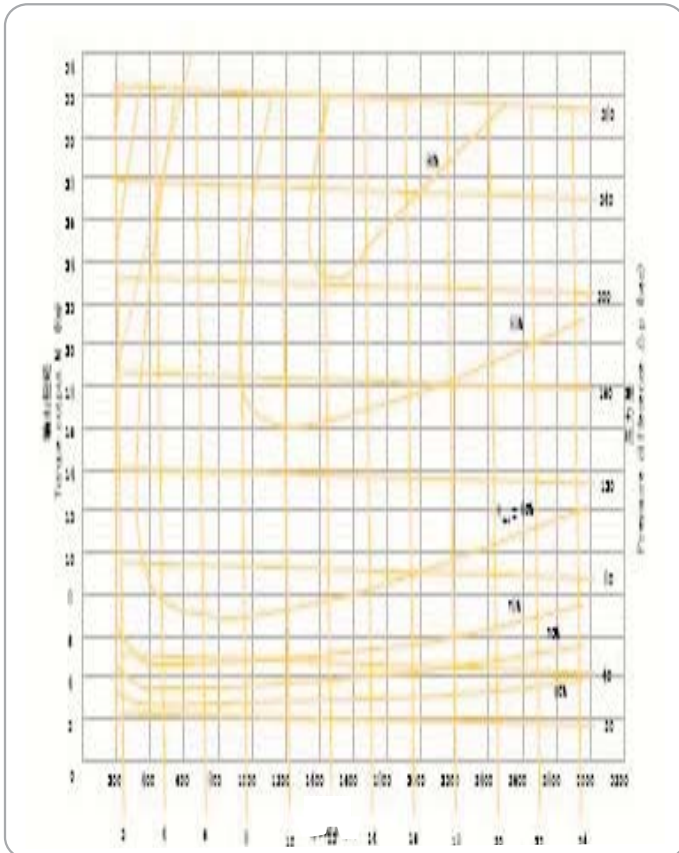

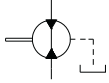

2 MF

İki Yönlü Dişli Motor / 2MF Bi-Direction Gear Motor

2MF11 Karakteristik Tablosu / Charactenstic Curves Of 2MF11

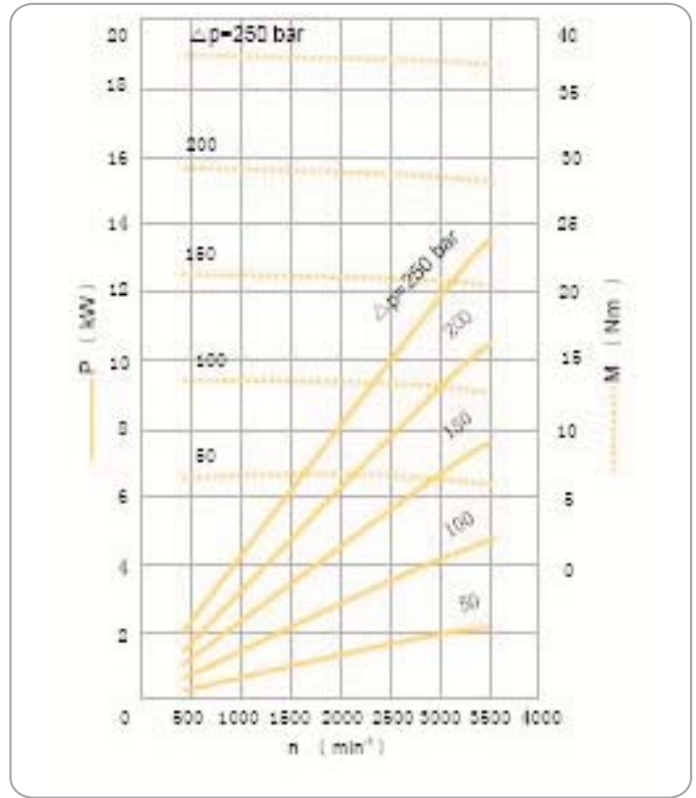
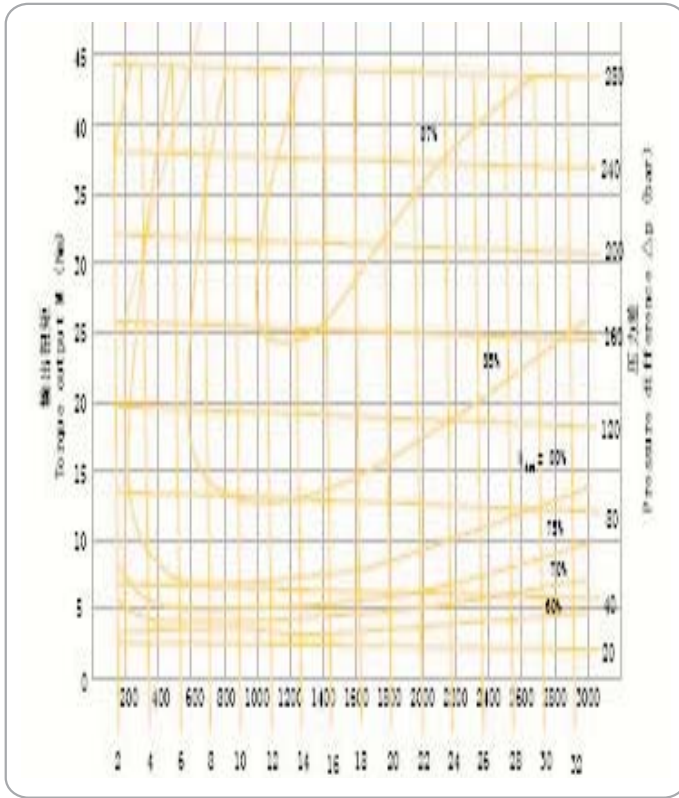

2MF14 Karakteristik Tablosu / Charactenstic Curves Of 2MF14

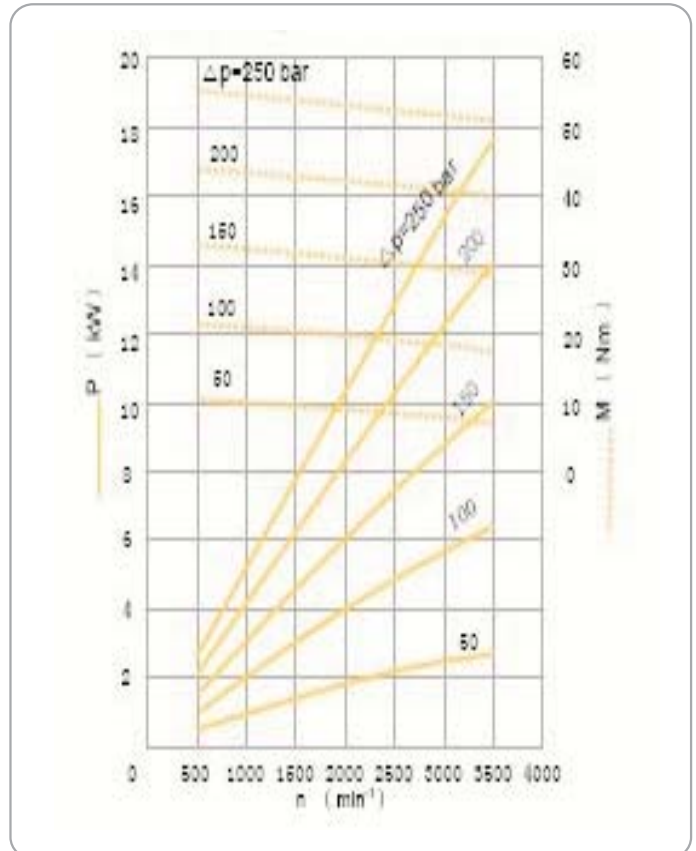
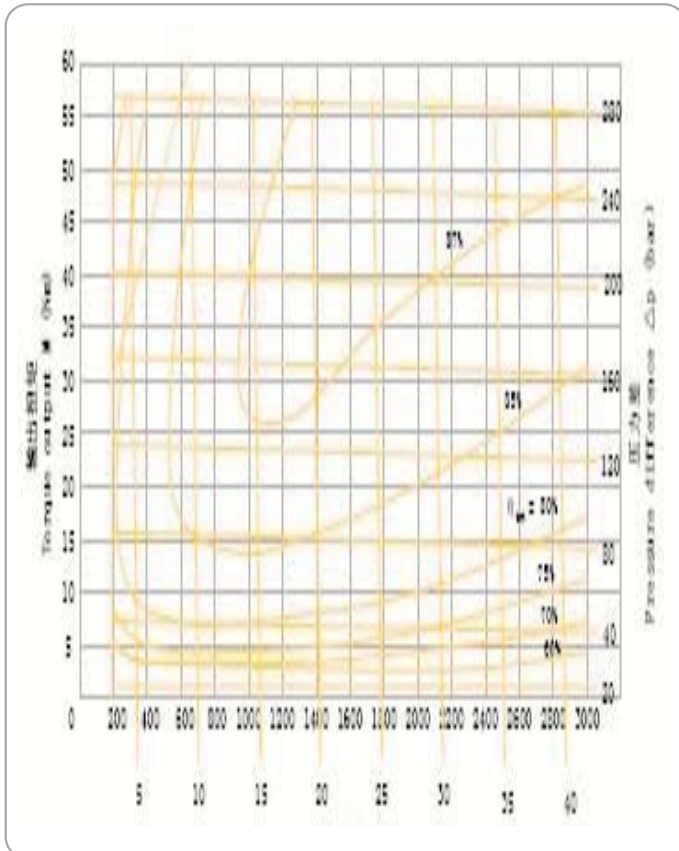

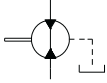

2 MF

İki Yönlü Dişli Motor / 2MF Bi-Direction Gear Motor

2MF16 Karakteristik Tablosu / Charactenstic Curves Of 2MF16

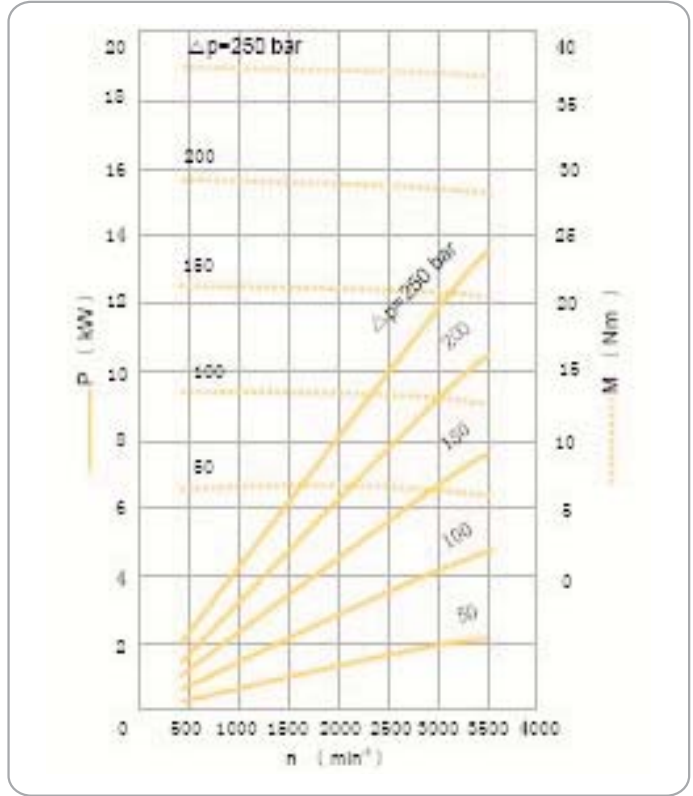
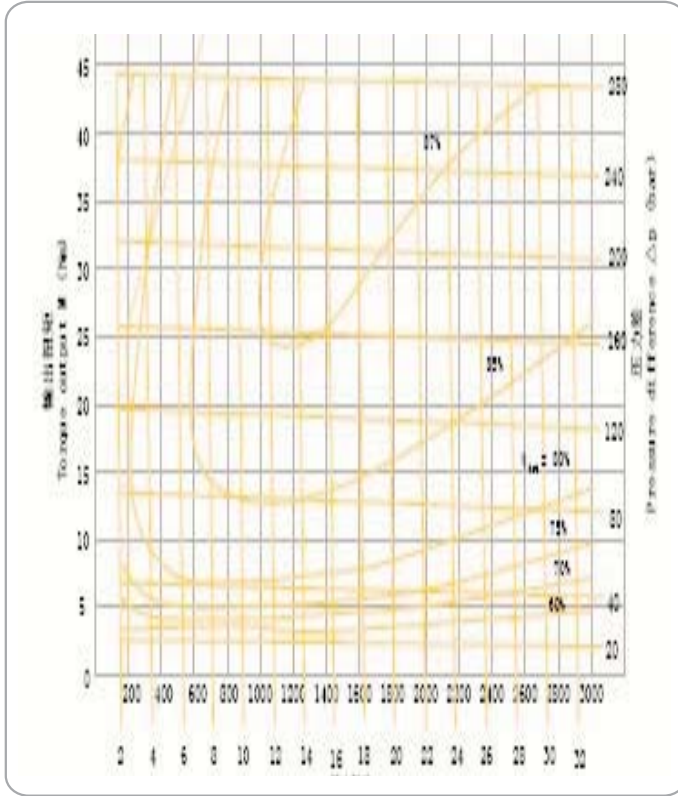

2MF19 Karakteristik Tablosu / Charactenstic Curves Of 2MF19

