

WINMAN V Serisi Solenoid Valfler.....	125-127	WINMAN Havalı Hidrolik Yağ Soğutucuları.....	148-149
WINMAN D Serisi Solenoid Valfler.....	128	WINMAN WLS Sulu Hidrolik Yağ Soğutucuları.....	150
WINMAN V Serisi DN16,25,32 Solenoid Valfler.....	129	WINMAN VAPU-VDPÜ Serileri Powerpack Hidrolik Üniteler.....	151-152
WINMAN Oransal Valfler.....	130	WINMAN Basınç Filtreleri.....	153
WINMAN Oransal Kontrollü Valfler.....	131-133	WINMAN Dönüş Filtreleri.....	153-154
WINMAN FS Serisi Mod. Kumanda Kolu.....	134	WINMAN Basınç Şalterleri.....	154-156
WINMAN Modüler Valfler.....	135-136	WINMAN Minyatür Basınç Şalterleri.....	156-157
WINMAN Pleyt Tipi Emniyet Valfleri.....	135-136	WINMAN Seviye Şalterleri.....	158
WINMAN Pleyt Tipi Çekvalfler.....	136	WINMAN Hidrolik Silindir Aksesuarları.....	158
WINMAN Hidrolik Komponentler.....	137	WINMAN Hidrolik Valf Pleytleri.....	159-161
WINMAN Hidrolik Short Strok Manyetik Silindirler.....	137	WINMAN Hidrolik Mobil Valfler.....	162-163
WINMAN Sabit Debili Paletli Pompalar.....	138	WINMAN Hidrolik Mobil Valfler ve Katriçler.....	164-165
WINMAN R Serisi Paletli Pompa Katriçleri.....	138	WINMAN Hidrolik Katriçler.....	166-173
WINMAN Tandem Paletli Pompalar.....	139	WINMAN Hidrolik Bobin ve Aksesuarları.....	174
WINMAN Sabit Debili Paletli Pompalar.....	139	WINMAN Hidrolik Oransal Katriçler.....	175
WINMAN WPV2R Serisi Tandem Paletli Pompa Katriçleri.....	139	WINMAN Hidrolik Komponentler.....	175-180
WINMAN Basınç Regülasyonlu Tandem Paletli Pom.....	139	WINMAN Ami Hidrolik Kumanda Kolları.....	181
WINMAN Hidrolik Değişken Debili AXIAL Pistonlu Pom.....	140	WINMAN Hidrolik Basınç Yükselticiler.....	181
WINMAN WA10V Serisi Pistonlu Pompalar.....	140	WINMAN Hortumlar.....	182
WINMAN Hidrolik Güç Regülasyonlu Pistonlu Pom.....	141	WINMAN Bezli Sargılı Hortum 10 Bar.....	182
WINMAN Sabit Debili Pistonlu Pompalar.....	141	FREEWAY Lojik Valfler.....	183
WINMAN Hidrolik Döküm Gövde Dişli Pompalar.....	141	WINMAN Fox Aküler.....	183-184
WINMAN Dişli Akış Bölücüler.....	141	WINMAN Fox Basınç Şalteri.....	185
WINMAN Alüminyum Dişli Pompalar.....	142-143	WINMAN Fox Seviye Şalteri.....	185
WINMAN Tandeme Uygun Alüminyum Dişli Pompalar.....	143-144	HERMANN Hidrolik Solenoid Valfler.....	186
WINMAN Alüminyum Dişli Motorlar.....	144	WINMAN Hidrolik Devre Boruları.....	187
WINMAN Direksiyon Kontrol Üniteleri.....	145	WINMAN Sıkıştırılmış Döküm Çubuklar.....	187
WINMAN Hidromotorlar.....	145-146		
WINMAN W Serisi Hidromotorlar.....	147		
WINMAN Yağlama Ünite ve Fitingleri.....	147		

hidrolik

A-Z

WINMAN	Alüminyum Dişli Motorlar.....	144	WINMAN	Hidrolik Silindir Aksesuarları.....	158
WINMAN	Alüminyum Dişli Pompalar.....	142-143	WINMAN	Hidrolik Silindir Aksesuarları.....	181
WINMAN	Ami Hidrolik Kumanda Kolları.....	181	HERMANN	Hidrolik Solenoid Valfler.....	186
WINMAN	Basınç Filtreleri.....	153	WINMAN	Hidrolik Valf Pleytleri.....	159-161
WINMAN	Basınç Regülasyonlu Tandem Paletli Pom.....	139	WINMAN	Hidromotorlar.....	145-146
WINMAN	Basınç Şalterleri.....	154-156	WINMAN	Hortumlar.....	182
WINMAN	Bezli Sargılı Hortum 10 Bar.....	182	FREEWAY	Lojik Valfler.....	183
WINMAN	D Serisi Solenoid Valfler.....	128	WINMAN	Minyatür Basınç Şalterleri.....	156-157
WINMAN	Delik Körleme Tapaları.....	161	WINMAN	Modüler Valfler.....	135-136
WINMAN	Direksiyon Kontrol Üniteleri.....	145	WINMAN	Oransal Kontrollü Valfler.....	131-133
WINMAN	Dişli Akış Bölücüler.....	141	WINMAN	Oransal Valfler.....	130
WINMAN	Dönüş Filtreleri.....	153-154	WINMAN	Pleyt Tipi Çekvalfler.....	136
WINMAN	Fox Aküler.....	183-184	WINMAN	Pleyt Tipi Emniyet Valfleri.....	135-136
WINMAN	Fox Basınç Şalteri.....	185	WINMAN	R Serisi Paletli Pompa Katriçleri.....	138
WINMAN	Fox Seviye Şalteri.....	185	WINMAN	Sabit Debili Paletli Pompalar.....	138
WINMAN	FS Serisi Mod. Kumanda Kolu.....	134	WINMAN	Sabit Debili Pistonlu Pompalar.....	141
WINMAN	Havalı Hidrolik Yağ Soğutucuları.....	148-149	WINMAN	Seviye Şalterleri.....	158
WINMAN	Hidrolik Basınç Yükselticiler.....	181	WINMAN	Sıkıştırılmış Döküm Çubuklar.....	187
WINMAN	Hidrolik Bobin ve Aksesuarları.....	174	WINMAN	Tandem Paletli Pompalar.....	139
WINMAN	Hidrolik Değişken Debili AXIAL Pistonlu Pom.....	140	WINMAN	Tandeme Uygun Alüminyum Dişli Pompalar.....	143-144
WINMAN	Hidrolik Devre Boruları.....	187	WINMAN	V Serisi DN16,25,32 Solenoid Valfler.....	129
WINMAN	Hidrolik Döküm Gövde Dişli Pompalar.....	141	WINMAN	V Serisi Solenoid Valfler.....	125-127
WINMAN	Hidrolik Güç Regülasyonlu Pistonlu Pom.....	141	WINMAN	VAPU-VDP Serileri Powerpack Hidrolik Üniteler.....	152-152
WINMAN	Hidrolik Mobil Valfler ve Katriçler.....	164-165	WINMAN	W Serisi Hidromotorlar.....	147
WINMAN	Hidrolik Katriçler.....	166-173	WINMAN	WA10V Serisi Pistonlu Pompalar.....	140
WINMAN	Hidrolik Katriçler.....	166-173	WINMAN	WLS Sulu Hidrolik Yağ Soğutucuları.....	150
WINMAN	Hidrolik Komponentler.....	137	WINMAN	WPV2R Serisi Tandem Paletli Pompa Katriçleri.....	139
WINMAN	Hidrolik Komponentler.....	175-180	WINMAN	Yağlama Ünite ve Fitingleri.....	147
WINMAN	Hidrolik Mobil Valfler.....	162-163			
WINMAN	Hidrolik Oransal Katriçler.....	175			
WINMAN	Hidrolik Short Strok Manyetik Silindirler.....	137			

WINMAN V SERİSİ SOLENOID VALFLER

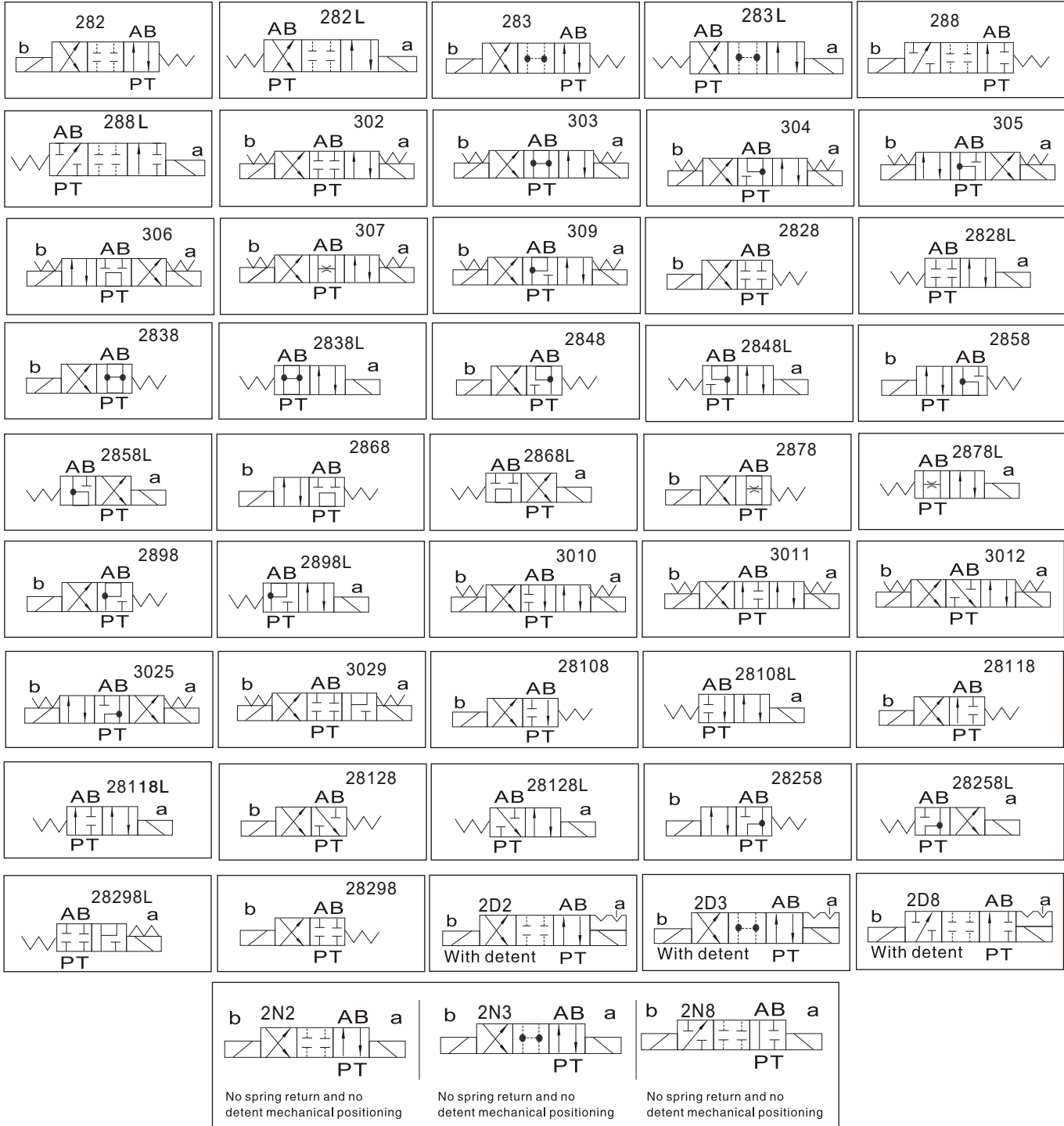

WINMAN V SERİSİ SOLENOID VALFLER

WINMAN NG6 SOLENOID VALFLER

Kod	Ölçü	Max. Debi Lt/Dk.	Max. Basiç Bar
WHV6-302	NG6	80	350
WHV6-303	NG6	80	350
WHV6-304	NG6	80	350
WHV6-305	NG6	80	350
WHV6-306	NG6	80	350
WHV6-307	NG6	80	350
WHV6-309	NG6	80	350
WHV6-3010	NG6	80	350
WHV6-3011	NG6	80	350
WHV6-3012	NG6	80	350
WHV6-3025	NG6	80	350
WHV6-3029	NG6	80	350
WHV6-2828	NG6	80	350
WHV6-2838	NG6	80	350
WHV6-2848	NG6	80	350
WHV6-2858	NG6	80	350
WHV6-2868	NG6	80	350
WHV6-2878	NG6	80	350
WHV6-2898	NG6	80	350
WHV6-28108	NG6	80	350
WHV6-28118	NG6	80	350
WHV6-28128	NG6	80	350
WHV6-28258	NG6	80	350
WHV6-2828L	NG6	80	350
WHV6-2838L	NG6	80	350
WHV6-2848L	NG6	80	350
WHV6-2858L	NG6	80	350
WHV6-2868L	NG6	80	350
WHV6-2878L	NG6	80	350
WHV6-2898L	NG6	80	350
WHV6-28108L	NG6	80	350
WHV6-28118L	NG6	80	350
WHV6-28128L	NG6	80	350
WHV6-28258L	NG6	80	350
WHV6-282	NG6	80	350
WHV6-283	NG6	80	350
WHV6-288	NG6	80	350
WHV6-282L	NG6	80	350
WHV6-283L	NG6	80	350
WHV6-288L	NG6	80	350
WHV6-2D2	NG6	80	350
WHV6-2D3	NG6	80	350



Not:Bobin voltajları 12V DC,24V DC,110V AC,220V AC.
 Aralarında fiyat farkı bulunmamaktadır.

WINMAN V SERİSİ SOLENOID VALFLER

WINMAN NG10 SOLENOID VALFLER



Kod	Ölçü	Max.Debi Lt/Dk.	Max.Basınç Bar	
WHV10-302	NG10	120	315	
WHV10-303	NG10	120	315	
WHV10-304	NG10	120	315	
WHV10-305	NG10	120	315	
WHV10-306	NG10	120	315	
WHV10-307	NG10	120	315	
WHV10-309	NG10	120	315	
WHV10-3010	NG10	120	315	
WHV10-3011	NG10	120	315	
WHV10-3012	NG10	120	315	
WHV10-3025	NG10	120	315	
WHV10-3029	NG10	120	315	
WHV10-2828	NG10	120	315	
WHV10-2838	NG10	120	315	
WHV10-2848	NG10	120	315	
WHV10-2858	NG10	120	315	
WHV10-2868	NG10	120	315	
WHV10-2878	NG10	120	315	
WHV10-2898	NG10	120	315	
WHV10-28108	NG10	120	315	
WHV10-28118	NG10	120	315	
WHV10-28128	NG10	120	315	
WHV10-28258	NG10	120	315	
WHV10-2828L	NG10	120	315	
WHV10-2838L	NG10	120	315	
WHV10-2848L	NG10	120	315	
WHV10-2858L	NG10	120	315	
WHV10-2868L	NG10	120	315	
WHV10-2878L	NG10	120	315	
WHV10-2898L	NG10	120	315	
WHV10-28108L	NG10	120	315	
WHV10-28118L	NG10	120	315	
WHV10-28128L	NG10	120	315	
WHV10-28258L	NG10	120	315	
WHV10-282	NG10	120	315	
WHV10-283	NG10	120	315	
WHV10-288	NG10	120	315	
WHV10-282L	NG10	120	315	
WHV10-283L	NG10	120	315	
WHV10-288L	NG10	120	315	
WHV10-2D2	NG10	120	315	
WHV10-2D3	NG10	120	315	

Not:Bobin voltajları 12V DC,24V DC,110V AC,220V AC.
Aralarında fiyat farkı bulunmamaktadır.

WINMAN D SERİSİ SOLENOID VALFLER

NG 6 SERİSİ

Kod	Konum	Max. Debi Lt./Dk.	Max. Basiç Bar
DFA-02-3C2	K.M.	100	350
DFA-02-3C3	H.M.	100	350
DFA-02-3C4	A.B.T	100	350
DFA-02-3C5	P.A.T. Açık B Açık	50	350
DFA-02-3C10	B.T Açık P.A Kapalı	50	250
DFA-02-3C12	P.B Kapalı A.T Açık	80	350
DFA-02-3C25	P.B.T Açık A Kapalı	50	350
DFA-02-2D3	Krameyerli	65	350
DFA-02-2B2	Düz-Çapraz	80	350
DFA-02-2B3	Düz-Çapraz	65	350
DFA-02-2B3B	H.M.-Çapraz	65	350
DFA-02-2B2B	K.M.-Çapraz	80	350
DFA-02-2B3A	Düz - H.M	65	350
DFA-02-2B3BL	H.M. - Düz	65	350
DFA-02-2B2BL	K.M. - Düz	80	350
DFA-02-2B2A	Düz - K.M.	80	350
DFA-02-2B11B	T.B P.A Açık B.T Kapalı	80	350
DFA-02-2B3L	Çapraz - Düz	65	350



NG 10 SERİSİ

Kod	Voltaj	Konum	Max. Debi Lt./Dk.	Max. Basiç Bar
DFA-03-3C2	AC	K.M	130	350
DFA-03-3C2	DC	K.M	160	350
DFA-03-3C3	AC	H.M	130	350
DFA-03-3C3	DC	H.M	160	350
DFA-03-3C4	AC	A.B.T	130	350
DFA-03-3C4	DC	A.B.T	160	350
DFA-03-3C60	AC	A.M	70	250
DFA-03-3C60	DC	A.M	100	250
DFA-03-3C9	AC	Rejeneratif	130	350
DFA-03-3C9	DC	Rejeneratif	160	350
DFA-03-2D3	AC	Krameyerli	130	350
DFA-03-2D3	DC	Krameyerli	160	350
DFA-03-2D2	AC	Krameyerli	130	350
DFA-03-2D2	DC	Krameyerli	160	350
DFA-03-2B2	AC	TB	130	350
DFA-03-2B2	DC	TB	160	350
DFA-03-2B8	AC	TB	40	350
DFA-03-2B8	DC	TB	85	350
DFA-03 2B3AL	AC	TB	100	350
DFA-03 2B3AL	DC	TB	100	350
DFA-03-2B2A	AC	Düz-K.M	130	350
DFA-03-2B2A	DC	Düz-K.M	160	350
DFA-03-2B3BL	AC	H.M-Düz	130	350
DFA-03-2B3BL	DC	H.M-Düz	160	350
DFA-03-2B2B	AC	K.M-Çapraz	130	350
DFA-03-2B2B	DC	K.M-Çapraz	160	350

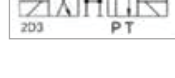
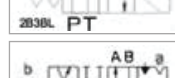
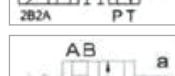
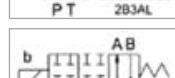
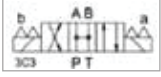
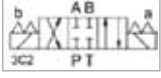
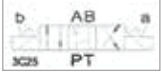

NG 16 HİDROLİK VALFLER (PİLOT VALFİ FİYATA DAHİL DEĞİLDİR.)

Kod	Konum	Max. Debi Lt./Dk.	Max. Debi Bar
DHG-04-3C3	H.M.	200	250

NG 25 HİDROLİK VALF BLOKLARI (PİLOT VALFİ FİYATA DAHİL DEĞİLDİR.)

Kod	Konum	Max. Debi Lt./Dk.	Max. Debi Bar
DHG-06-3C3	H.M.	400	250
DHG-06-3C60	A.M.	400	250



Not: Bobin voltajları 12V DC, 24V DC, 110V AC, 220V AC.
Aralarında fiyat farkı bulunmamaktadır.

WINMAN V SERİSİ DN16,25,32 SOLENOID VALFLER

WINMAN NG16 SOLENOID VALFLER



Kod	Ölçü	Max. Debi Lt/Dk.	Max. Basınç Bar	
WHVH-DN16-302	DN16	300	280	
WHVHH-DN16-302	DN16	300	350	
WHVH-DN16-303	DN16	300	280	
WHVHH-DN16-303	DN16	300	350	
WHVH-DN16-304	DN16	300	280	
WHVHH-DN16-304	DN16	300	350	
WHVH-DN16-306	DN16	300	280	
WHVHH-DN16-306	DN16	300	350	
WHVH-DN16-282	DN16	300	280	

WINMAN NG25 SOLENOID VALFLER



Kod	Ölçü	Max. Debi Lt/Dk.	Max. Basınç Bar	
WHVH-DN25-302	DN25	650	280	
WHVHH-DN25-302	DN25	650	350	
WHVH-DN25-303	DN25	650	280	
WHVHH-DN25-303	DN25	650	350	
WHVH-DN25-304	DN25	650	280	
WHVHH-DN25-304	DN25	650	350	
WHVH-DN25-306	DN25	650	280	
WHVHH-DN25-306	DN25	650	350	
WHVH-DN25-282	DN25	650	280	

WINMAN NG32 SOLENOID VALFLER

Kod	Ölçü	Max. Debi Lt/Dk.	Max. Basınç Bar	
WHVH-DN32-302	DN32	1100	280	
WHVH-DN32-303	DN32	1100	280	
WHVH-DN32-304	DN32	1100	280	
WHVH-DN32-306	DN32	1100	280	

Not : 1) Yön kontrol valfleri fiyata dahildir.

2) 303 ve 306 serilerinde ön gerilim valfi mevcuttur.

WINMAN SWITCH'Lİ HİDROLİK SOLENOID VALFLER

NG6 SWITCH'Lİ HİDROLİK VALF



Kod	Konum	Voltaj	Max. Debi Lt/Dk.	Max. Basınç Bar	
DFA-02-3C2.SWITCH'li	K.M.	24	100	315	
DFA-02-3C3.SWITCH'li	H.M.	24	100	315	
DFA-02-2B3B.SWITCH'li	T.B.	24	100	315	
DFA-02-2B3.SWITCH'li	T.B.	24	100	315	
DFA-02-3C60.SWITCH'li	A.M.	24	100	315	

NG10 SWITCH'Lİ HİDROLİK VALF

Kod	Konum	Voltaj	Max. Debi Lt/Dk.	Max. Basınç Bar	
DFA-03-3C2.SWITCH'li	K.M.	24	160	315	
DFA-03-3C60.SWITCH'li	A.M.	24	160	315	
DFA-03-2B3.SWITCH'li	T.B.	24	160	315	

Not: D12,A110,A220,R220 voltajları için bilgi alınır.Valfler tek switch'lidir.Çiftleri için bilgi alınır.
NG16,NG25,NG32 modelleri için bilgi alınır.

WINMAN ORANSAL VALFLER

WINMAN ORANSAL YÖN KONTROL VALFLERİ

Kod	Ölçü	Konum	Max.Debi Lt/Dk.	Voltaj	Max.Basınç Bar
WFW-06-302-07	NG6	KM	7	24V	315
WFW-06-302-15	NG6	KM	15	24V	315
WFW-06-302-30	NG6	KM	30	24V	315
WFW-06-304-07	NG6	ABT	7	24V	315
WFW-06-304-15	NG6	ABT	15	24V	315
WFW-06-304-30	NG6	ABT	30	24V	315
WFW-10-302-30	NG10	KM	30	24V	315
WFW-10-302-60	NG10	KM	60	24V	315
WFW-10-304-30	NG10	ABT	30	24V	315
WFW-10-304-60	NG10	ABT	60	24V	315



WINMAN ORANSAL YÖN KONTROL VALFLERİ KARTI ÜZERİNDE

Kod	Ölçü	Konum	Max.Debi Lt/Dk.	Voltaj	Max.Basınç Bar
WFWN-06-302-07	NG6	KM	7	24V	315
WFWN-06-302-15	NG6	KM	15	24V	315
WFWN-06-302-30	NG6	KM	30	24V	315
WFWN-06-304-07	NG6	ABT	7	24V	315
WFWN-06-304-15	NG6	ABT	15	24V	315
WFWN-06-304-30	NG6	ABT	30	24V	315
WFWN-10-302-30	NG10	KM	30	24V	315
WFWN-10-302-60	NG10	KM	60	24V	315
WFWN-10-304-30	NG10	ABT	30	24V	315
WFWN-10-304-60	NG10	ABT	60	24V	315

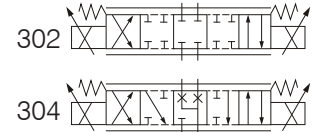
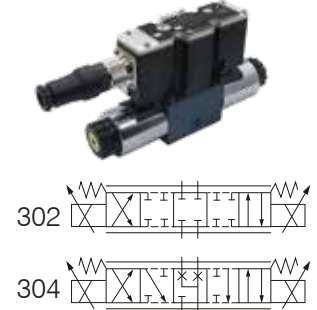

WINMAN ORANSAL YÖN KONTROL VALFLERİ KARTI ÜZERİNDE FEED BACKLI

Kod	Ölçü	Konum	Max.Debi Lt/Dk.	Voltaj	Max.Basınç Bar
WFWNE-06-302-08	NG6	KM	8	24V	315
WFWNE-06-302-16	NG6	KM	16	24V	315
WFWNE-06-302-32	NG6	KM	32	24V	315
WFWNE-06-304-08	NG6	ABT	8	24V	315
WFWNE-06-304-16	NG6	ABT	16	24V	315
WFWNE-06-304-32	NG6	ABT	32	24V	315
WFWNE-10-302-25	NG10	KM	25	24V	315
WFWNE-10-302-50	NG10	KM	50	24V	315
WFWNE-10-302-75	NG10	KM	75	24V	315
WFWNE-10-304-25	NG10	ABT	25	24V	315
WFWNE-10-304-50	NG10	ABT	50	24V	315
WFWNE-10-304-75	NG10	ABT	75	24V	315

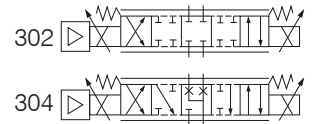
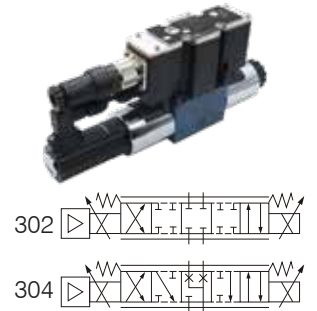

NG 10 ORANSAL YÖN KONTROL VALFLERİ(FEEDBACK KART HARIÇ)

Kod	Konum	Max. Debi Lt./Dk.	A/VA Max.
DPG-03-3C40-32	A.B.T	32	315
DPG-03-3C40-63	A.B.T	63	315
DPE-120 Oransal Kart	A.B.T		



WINMAN ORANSAL KONTROLLÜ VALFLER

WINMAN NG 6 ORANSAL YÖN KONTROL VALFLERİ(KART ÜZERİNDE)



Kod	Konum	Voltaj	Max. Debi Lt./Dk.	Max. Basınç Bar
DPGE-6-2B2B-07	T.B.	24	7	315
DPGE-6-2B2B-15	T.B.	24	15	315
DPGE-6-2B2B-30	T.B.	24	30	315
DPGE-6-2B40B-07	T.B.	24	7	315
DPGE-6-2B40B-15	T.B.	24	15	315
DPGE-6-2B40B-30	T.B.	24	30	315

WINMAN NG 10 ORANSAL YÖN KONTROL VALFLERİ(KART ÜZERİNDE)

Kod	Konum	Max. Debi Lt./Dk.	Max. Basınç Bar
DPGE-10-2B2B-30	T.B.	30	315
DPGE-10-2B2B-60	T.B.	60	315
DPGE-10-2B40B-30	T.B.	30	319
DPGE-10-2B40B-60	T.B.	60	315

Not: PLUG konnektörleri fiyata dahildir.

WINMAN 6 ORANSAL YÖN KONTROL VALFLERİ (FEEDBACKLİ KART DAHİL)



Kod	Konum	Voltaj	Max. Debi Lt./Dk.	Max. Basınç Bar
DPGEE-6-2B2B-8	T.B.	24	8	315
DPGEE-6-2B2B-16	T.B.	24	16	315
DPGEE-6-2B2B-32	T.B.	24	32	315
DPGEE-6-2B40B-08	T.B.	24	8	315
DPGEE-6-2B40B-16	T.B.	24	16	315
DPGEE-6-2B40B-32	T.B.	24	32	315

WINMAN10 ORANSAL YÖN KONTROL VALFLERİ (FEEDBACKLİ KART DAHİL)

Kod	Konum	Voltaj	Max. Debi Lt./Dk.	Max. Basınç Bar
DPGEE-10-3C40-50	A.B.T	24	50	315
DPGEE-10-2B2B-25	T.B.	24	25	315
DPGEE-10-2B2B-50	T.B.	24	50	315
DPGEE-10-2B40B-25	T.B.	24	25	315
DPGEE-10-2B40B-50	T.B.	24	50	315
DPGEE-10-2B40B-70	T.B.	24	75	315

ORANSAL ELEKTRO-HİDROLİK BASINÇ KONTROL VALFLERİ(FEEDBACK KART HARIÇ)



Kod	Basınç Aralığı Bar	Max. Debi Lt./Dk.	A/VA Max.
PPG-02-250	5,0 & 250	1	3,72 / 62

PPE-102 Basınç Oransal Kartı

ORANSAL ELEKTRO-HİDROLİK HIZ KONTROL VALFLERİ(FEEDBACK KART HARIÇ)



Kod	Max. Debi Lt./Dk.	Basınç Aralığı Bar	A/VA Max.
QPG-03-16	16	P.A.B. :315	3,72/62

QPE-104 Akış Oransal Kartı

ORANSAL BASINÇ EMNİYET VALFİ (KART HARIÇ)

Kod	Açıklama
EBG-03 H 10	Oransal Valf

WINMAN ORANSAL KONTROLLÜ VALFLER

WINMAN ORANSAL BASINÇ EMNİYET VALFLERİ

Kod	Ölçü	Max.Debi Lt/Dk.	Max.Basınç Bar
WYZ-6-7	NG6	2	70
WYZ-6-16	NG6	2	160
WYZ-6-25	NG6	2	250
WYZ-6-31,5	NG6	2	315

WINMAN ORANSAL EMNİYET VALFLERİ

Kod	Max.Debi Lt/Dk.	Çalışma Basıncı Bar	Max.Basınç Bar
WBEME-03-7	100	70	315
WBEME-03-16	100	160	315
WBEME-03-25	100	250	315
WBEME-06-7	200	70	315
WBEME-06-16	200	160	315
WBEME-06-25	200	250	315
WBEME-10-7	400	70	315
WBEME-10-16	400	160	315
WBEME-10-25	400	250	315

Not: Oransal valf için kart veya soket ayrıca satılmaktadır.

WINMAN ORANSAL BASINÇ DÜŞÜRÜCÜ VALFLERİ (ÇEKVALFLİ)

Kod	Max.Debi Lt/Dk.	Çalışma Basıncı Bar	Max.Basınç Bar
WREE-03-16D	80	160	315
WREE-06-16D	200	160	315

Not: Oransal valf için kart veya soket ayrıca satılmaktadır.

WINMAN ORANSAL BASINÇ ve HIZ KONTROL VALFİ (P-Q)

Kod	Akış Aralığı Lt/Dk.	Çalışma Basıncı Min. Bar	Max.Basınç Bar
WFBG-02-20-31,5	1-20	1,5	315
WFBG-02-40-31,5	1-40	1,5	315
WFBG-03-125-31,5	2-125	1,5	315
WFBG-06-250-31,5	3-250	1,5	315

WINMAN ORANSAL 3 YOLLU HIZ KONTROL VALFİ (Q)

Kod	Akış Aralığı Lt/Dk.	Çalışma Basıncı Min. Bar	Bar
WFBG-02-20-3	1-20	1,5	315
WFBG-02-40-3	1-40	1,5	315

Not: Oransal valf için kart veya soket ayrıca satılmaktadır.

ORANSAL VALF KONTROL KARTLARI

Kod	Açıklama
Oransal Kart	P&Q Kartı
PPE-102	P Kartı Feedback
QPG-076	Hız Kartı Feedback

€/Adet

WCPR-1-0	Oransal Kartlı Soket
----------	----------------------

ORANSAL KART MONTAJ KILAVUZLAMASI

Kod	Açıklama
QPF-001	Oransal Kart Montaj Kılavuzlaması

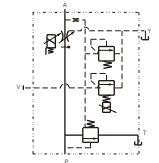
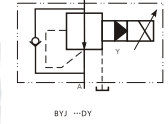
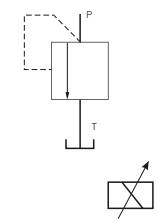
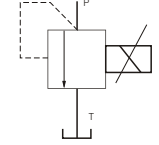

WINMAN ORANSAL KONTROLLÜ VALFLER



ORANSAL VALF YEDEK BOBİNLERİ

Kod	
EFBG Hız Bobini	

YEDEK BOBİNLER

Kod	Ölçü	Voltaj	
FOR DFA-02-DC12	NG6	12DC	
FOR DFA-02-DC24	NG6	24DC	
FOR DFA-02-AC 110	NG6	110AC	
FOR DFA-02-AC220	NG6	220AC	
FOR DFA-03-DC12	NG10	12DC	
FOR DFA-03-DC24	NG10	24DC	
FOR DFA-03-AC110	NG10	110AC	
FOR DFA-03-AC220	NG10	220AC	

Kod	Konum	Kontrol	Seri	
WDS-3C3	H.M.	Hava-Hava	NG6	

Kod	Ölçü	Max. Debi Lt/Dk	Max. Basınç Bar	
GDFW-02-3C60-D24-52 EXPROF YÖN VALFİ	NG6	80	315	
GDFW-02-3C2-D24-50 EXPROF YÖN VALFİ	NG6	80	315	
GDFW-02-3C4-D24-52 EXPROF YÖN VALFİ	NG6	80	315	
GDFW-02-3C3-D24-50 EXPROF YÖN VALFİ	NG6	80	315	

WINMAN FS SERİSİ MOD.KUMANDA KOLU



Kod	Ölçü	Hareket	Max. Debi Lt/Dk	Max. Basınç Bar	
FS-02-3C60-50 MOD.KUMANDA KOLU	NG6	Yay Dönüslü	60	315	
FS-02-3C2-50 MOD.KUMANDA KOLU	NG6	Yay Dönüslü	60	315	
FS-02-3C4-50 MOD.KUMANDA KOLU	NG6	Yay Dönüslü	60	315	
FS-02-3C3-50 MOD.KUMANDA KOLU	NG6	Yay Dönüslü	60	315	
FS-02-2B2-50 MOD.KUMANDA KOLU	NG6	Yay Dönüslü	60	315	
FS-02-2B2 MOD.KUMANDA KOLU	NG6	Kremayerli	60	315	
FS-02-3C60 MOD.KUMANDA KOLU	NG6	Kremayerli	60	315	
FS-02-3C2 MOD.KUMANDA KOLU	NG6	Kremayerli	60	315	
FS-02-3C4 MOD.KUMANDA KOLU	NG6	Kremayerli	60	315	
FS-02-303 MOD.KUMANDA KOLU	NG6	Kremayerli	60	315	

Kod	Ölçü	Hareket	Max. Debi Lt/Dk	Max. Basınç Bar	
FS-03-3C3 MOD.KUMANDA KOLU	NG10	Kremayerli	100	315	
FS-03-3C2 MOD.KUMANDA KOLU	NG10	Kremayerli	100	315	
FS-03-3C4 MOD.KUMANDA KOLU	NG10	Kremayerli	100	315	
FS-03-3C60 MOD.KUMANDA KOLU	NG10	Kremayerli	100	315	
FS-03-3C60-50 MOD.KUMANDA KOLU	NG10	Yay Dönüslü	100	315	
FS-03-3C2-50 MOD.KUMANDA KOLU	NG10	Yay Dönüslü	100	315	
FS-03-3C4-50 MOD.KUMANDA KOLU	NG10	Yay Dönüslü	100	315	
FS-03-3C3-50 MOD.KUMANDA KOLU	NG10	Yay Dönüslü	100	315	
FS-03-2B2-50 MOD.KUMANDA KOLU	NG10	Yay Dönüslü	100	315	

WINMAN MODÜLER VALFLER

WINMAN MODÜLER ÇEKVALF

Kod	Ölçü	Max. Debi Lt/Dk.	Max. Basınç Bar
WMC-02-P-a	NG6	40	250
WMC-03-P-a	NG10	70	250

WINMAN MODÜLER KİLİTLEME VALFLERİ

Kod	Ölçü	Max. Debi Lt/Dk.	Max. Basınç Bar
WMPC-02-A-a A Hattı	NG6	40	250
WMPC-02-B-a B Hattı	NG6	40	250
WMPC-02-W-a İkiz	NG6	40	250
WMPC-03-A-a A Hattı	NG10	70	250
WMPC-03-B-a B Hattı	NG10	70	250
WMPC-03-W-a İkiz	NG10	70	250
WMPC-04-W-a İkiz	NG16	120	210
WMPC-06-W-a İkiz	NG25	160	210

MODÜLER ÇEKVALFLER

Kod	Ölçü	Max. Debi Lt./Dk.	Max. Basınç Bar
MC-02-P Hattı	NG6	40	250
MC-02-A Hattı	NG6	40	250

WINMAN MODÜLER EMNİYET VALFİ

Kod	Ölçü	Max. Debi Lt/Dk.	Max. Basınç Bar	Emniyet Hattı
WMR-02-P-20	NG6	35	200	P
WMR-02-P-31,5	NG6	35	315	P
WMR-02-A-20	NG6	35	200	A
WMR-02-A-31,5	NG6	35	315	A
WMR-02-B-20	NG6	35	200	B
WMR-02-B-31,5	NG6	35	315	B
WMR-02-W-20	NG6	35	200	A-B
WMR-02-W-31,5	NG6	35	315	A-B
WMR-03-P-20	NG10	70	200	P
WMR-03-P-31,5	NG10	70	315	P
WMR-03-A-20	NG10	70	200	A
WMR-03-A-31,5	NG10	70	315	A
WMR-03-B-20	NG10	70	200	B
WMR-03-B-31,5	NG10	70	315	B
WMR-03-W-20	NG10	70	200	A-B
WMR-03-W-31,5	NG10	70	315	A-B

WINMAN MODÜLER BASINÇ DÜŞÜRÜCÜ VALFİ

Kod	Ölçü	Max. Debi Lt/dk.	Max. Basınç Bar
WMPR-02-P-21	NG6	35	210
WMPR-02-A-21	NG6	35	210
WMPR-02-B-21	NG6	35	210
WMPR-03-P-21	NG10	70	210
WMPR-03-A-21	NG10	70	210
WMPR-03-B-21	NG10	70	210

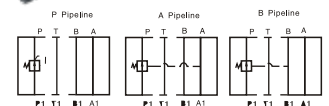
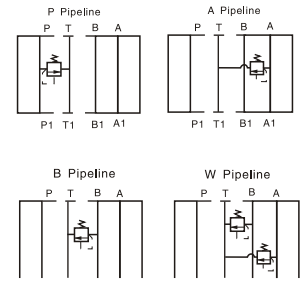

WINMAN MODÜLER VALFLER

MODÜLER BASINÇ DÜŞÜRÜCÜ VALFLER

Kod	Ölçü	Max. Debi Lt./Dk.	A/VA Max.
MPR-02-A Hattı	NG 6	40	250
MPR-02-B Hattı	NG 6	40	250
MPR-03-A Hattı	NG 10	70	250
MPR-03-B Hattı	NG 10	70	250
MPR-03-P Hattı	NG 10	70	250

WINMAN MODÜLER ÇEKİLİ HIZ AYAR VALFİ

Kod	Ölçü	Max. Debi Lt/Dk.	Max. Basınç Bar
WMTC-02-A	NG6	30	315
WMTC-02-B	NG6	30	315
WMTC-02-W	NG6	30	315
WMTC-02-W-I	NG6	30	315
WMTC-03-A	NG10	50	315
WMTC-03-B	NG10	50	315
WMTC-03-W	NG10	50	315

WINMAN MODÜLER ÇEKİSİZ HIZ AYAR VALFİ

Kod	Ölçü	Max. Debi Lt/dk.	Max. Basınç Bar
WDL-02-P	NG6	30	315
WDL-02-A	NG6	30	315
WDL-02-B	NG6	30	315
WDL-02-T	NG6	30	315
WDL-02-W	NG6	30	315
WDL-03-P	NG10	50	315
WDL-03-A	NG10	50	315
WDL-03-B	NG10	50	315
WDL-03-T	NG10	50	315
WDL-03-W	NG10	50	315

WINMAN PLEYT TİPİ EMNİYET VALFLERİ

WINMAN HAT TİPİ EMNİYET VALFİ

Kod	Ölçü	Max. Debi Lt/Dk.	Max. Basınç Bar
BT06-A7	3/4"	200	70

WINMAN UNLOADING VALFİ PLEYT TİPİ

Kod	Ölçü	Max. Debi %10	Max. Debi %7	Max. Basınç Bar
WX-03-20	10	40	60	200
WX-06-20	25	80	120	200
WX-10-20	32	120	240	200

WINMAN UNLOADING VALFİ PİLOT DAHİL PLEYT TİPİ

Kod	Voltaj	Konum	Max. Flow		Max. Basınç Bar
			%10	%7	
WXW-03-20-A-D24	24V	N.K	40	80	200
WXW-06-20-A-D24	24V	N.K	80	120	200
WXW-10-20-A-D24	24V	N.K	120	240	200

WINMAN PLEYT TİPİ EMNİYET VALFLERİ

WINMAN EMNİYET VALFİ PLEYT TİPİ

Kod	Ölçü	Max. Debi Lt/Dk.	Max. Basiñ Bar
WDB-03-B-35	10	250	350
WDB-06-B-35	25	500	350
WDB-10-B-35	32	650	350

WINMAN EMNİYET VALFİ PİLOT DAHİL PLEYT TİPİ

Kod	Konum	Ölçü	Max. Debi Lt/Dk.	Voltaj	Max. Basiñ Bar
WDBW-03-315B/D24	N.A	10	250	24V	350
WDBW-03-315B/B220	N.A	10	250	220V	350
WDBW-06-315B/D24	N.A	25	500	24V	350
WDBW-06-31B/220	N.A	25	500	220V	350
WDBW-10-315B-DC24	N.A	32	650	24V	350

WINMAN BASINÇ SIRALAMA PLET TİPİ

Kod	Ölçü	Max. Debi Lt/Dk.	Max. Basiñ Bar
WYS 03-20	10	250	315
WYS 06-20	25	500	315
WYS 10-20	32	600	315

PLEYT TİPİ BASINÇ EMNİYET VALFİ (YATIK) (PİLOT VALFİ HARIÇ)

Kod	Max. Debi	Açıklama
BSG-03	100	Mod. Yan. Mont. Sıfır. Emn. Valfi
BSG-06	200	Mod. Yan. Mont. Sıfır. Emn. Valfi
BSG-10	400	Mod. Yan. Mont. Sıfır. Emn. Valfi

PLEYT TİPİ BASINÇ EMNİYET VALFİ (YATIK)

Kod	Açıklama
BG-04	NG 16 Pleyt Tipi Emniyet Valfi
BG-06	NG 20 Pleyt Tipi Emniyet Valfi

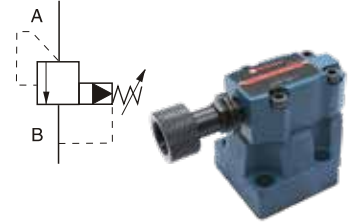
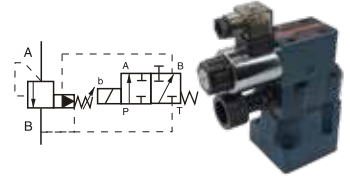
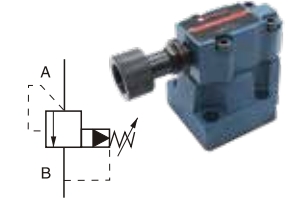

WINMAN PLEYT TİPİ ÇEKVALFLER

WINMAN PLEYT TİPİ ÇEKVALF

Kod	Ölçü	Max. Debi Lt/Dk.	Açma Basıncı	Max. Basiñ Bar
WCRG-03-a	NG10	90	0,5	315
WCRG-06-a	NG20	220	0,5	315
WCRG-10-a	NG25	430	0,5	315

WINMAN PLEYT TİPİ PİLOTLU ÇEKVALF

Kod	Ölçü	Max. Debi Lt/Dk.	Açma Basıncı	Max. Basiñ Bar
WCPDG-03-A-b	DN10	100	3	315
WCPDG-06-A-b	DN20	350	3	315
WCPDG-10-A-b	DN30	550	3	315
WCPDG-20 DN20 G 1"-A-b	G1"	350	3	315
WCPDG-30 DN30 G 1 1/2"-A-b	G1 1/2"	550	3	315

PLEYT TİPİ ÇEKVALF

Kod	Max. Debi Lt/Dk.	Max. Basiñ Bar
CRG-06	125	250

PLEYT TİPİ PİLOTLU KİLİTLEME

Kod	Max. Debi Lt/Dk.	Max. Basiñ Bar
CPDG-06	125	250
CPDG-10	250	250

PLEYT TİPİ ÇİFT HIZ VALFİ

Kod	Max. Debi Lt/Dk.	Max. Basiñ Bar
SD-G-06	120	250

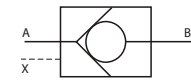

WINMAN HİDROLİK KOMPONENTLER

PLEYT TİPİ ÇEKİLİ HIZ AYAR VALFİ



Kod	Max. Debi Lt./Dk.	Max. Basınç Bar	
SRCG-03	30	250	
SRCG-06	80	250	
SRCG-10	200	250	

PLEYT TİPİ EMNİYET VE COUNTER BALANCE VALFİ



Kod	Max. Debi Lt./Dk.	Max. Basınç Bar	
HCG-06-C	125	70-140	
HCG-10-C	250	70-140	

PLEYT TİPİ HIZ AYAR VALFİ



OS1

Kod	Max. Debi Lt./Dk.	Max. Basınç Bar	
SRG-03	30	250	
SRG-06	80	250	
SRG-10	200	250	

HİDROLİK DÖNER KLEMP SAĞ (SR) VEYA SOL (SL)



OS2

Kod	Açıklama	
OS1-32x90	Hidrolik Döner Klemp	
OS1-50x90	Hidrolik Döner Klemp	
OS1-63x90	Hidrolik Döner Klemp	
OS1-40x90 DR-ST	Hidrolik Döner Klemp	

HİDROLİK DÖNER KLEMP SAĞ (SR) VEYA SOL (SL)



OS4

Kod	Açıklama	
OS2-32x90	Hidrolik Döner Klemp	
OS2-40x90	Hidrolik Döner Klemp	
OS2-50x90	Hidrolik Döner Klemp	
OS4-50	Hidrolik Klemp	

WINMAN HİDROLİK SHORT STROK MANYETİK SİLİNDİR

DİK MONTAJLI



Kod	
SD Ø32x20	
SD Ø32x30	
SD Ø32x40	
SD Ø32x50	
SD Ø40x10	
SD Ø40x30	
SD Ø40x50	
SD Ø50x30	
SD Ø50x50	
SD Ø63x20	
SD Ø63x25	
SD Ø80x50	



YATIK MONTAJLI

Kod	
LA Ø32x20	
LA Ø32x30	
LA Ø32x50	
LA Ø40x20	
LA Ø40x30	
LA Ø40x50	

WINMAN SABİT DEBİLİ PALETLİ POMPALAR

PALETLİ POMPALAR SERİSİ

Kod	Max. Debi cm ³ / dev.	Max. Basınç Bar
W2R1 6	6	210
W2R1 8	8	210
W2R1 10	10	210
W2R1 12	12	210
W2R1 14	14	210
W2R1 17	17	210
W2R1 19	19	210
W2R1 23	23	210
W2R1 25	25	210
W2R1 28	28	210
W2R1 31	31	160
W2R2 26	26	210
W2R2 33	33	210
W2R2 41	41	210
W2R2 47	47	210
W2R2 53	53	210
W2R2 59	59	210
W2R2 65	65	210
W2R2 75	75	210
W2R3 60	60	210
W2R3 66	66	210
W2R3 76	76	210
W2R3 85	85	210
W2R3 94	94	210
W2R3 116	116	210
W2R3 125	125	210
W2R3 136	136	210
W2R3 153	153	210



PALETLİ POMPALAR VQ SERİSİ

Kod	Max. Debi cm ³ / dev.	Max. Basınç Bar
VQ 15-11	11	240
VQ 15-17	17	240
VQ 15-19	19	240
VQ 25-22	22	230
VQ 25-26	26	230
VQ 25-32	32	230
VQ 25-38	38	230
VQ 25-43	43	230
VQ 25-75	75	230

Hidrolik

WINMAN R SERİSİ PALETLİ POMPA KATRIÇLERİ

Kod	cm ³
R1	6-8-10-12-14-17-19-23
R2	26-33-41-47-53-59-65-75
R3	66-76-85



WINMAN TANDEM PALETLİ POMPALAR



WINMAN TANDEM PALETLİ POMPALAR

Kod	cm ³	Bar	
WPV2R12	47-17	210-210	
WPV2R12	53-12	210-210	
WPV2R12	59-19	210-210	
WPV2R12	65-23	210-210	
WPV2R12	75-25	210-210	

Kod	cm ³	Bar	
WPV2R13	85-19	210-210	
WPV2R13	116-25	160-210	
WPV2R13	76-14	210-210	
WPV2R13	94-23	210-210	

Kod	cm ³	Bar	
WPV2R23	94-41	210-210	

Diğer tandem pompa çeşitleri için bilgi alınız.

WINMAN SABİT DEBİLİ PALETLİ POMPALAR



PALETLİ TANDEM POMPALAR

Kod	Debi cm ³ / dev.	Basınç Bar	
VQ225-52-26-F-R-B-A-02	52+26	245	
VQ225-75-38-F-R-B-A-02	75+38	245	
KT6CC-025-008-1 R-00-C1W1	80+26	240/275	

WINMAN WPV2R SERİSİ TANDEM PALETLİ POMPA KATRIÇLERİ



Kod	cm ³	Bar	
WPV2R1	6-8-10-12-14-17-19-23-25-38	210	
	31	160	

Kod	cm ³	Bar	
WPV2R2	26-33-41-47-53-59-65-75	210	

Kod	cm ³	Bar	
WPV2R3	52-60-66-76-85-94	160	

Kod	cm ³	Bar	
WPV2R3	116-125-136-153	160	

WINMAN BASINÇ REGÜLASYONLU TANDEM PALETLİ POMPALAR



DEĞİŞKEN DEBİLİ PALETLİ POMPALAR / WP SERİSİ

Kod	Açıklama	Debi Lt./Dk.	Basınç Bar
WP1-8	Basınç Regülasyonlu	8	50-70
WP1-12	Basınç Regülasyonlu	12	50-70
WP1-15	Basınç Regülasyonlu	15	50-70
WP1-20	Basınç Regülasyonlu	20	50-70
WP2-30	Basınç Regülasyonlu	30	50-70
WP2-40	Basınç Regülasyonlu	40	50-70
VPKC-F26	Basınç Regülasyonlu	26	50-70

WINMAN BASINÇ REGÜLASYONLU TANDEM PALETLİ POMPALAR

DEĞİŞKEN DEBİLİ PALETLİ POMPALAR

Kod	Açıklama	Debi Lt./Dk.	Basınç Bar
WWP1-8/8	Basınç Regülasyonu	8/8	50-70
WWP1-12/12	Basınç Regülasyonu	12/12	50-70
WWP1-15/15	Basınç Regülasyonu	15/15	50-70
WWP1-20/20	Basınç Regülasyonu	20/20	50-70
WWP2-30/30	Basınç Regülasyonu	30/30	50-70
WWP2-40/40	Basınç Regülasyonu	40/40	50-70



WINMAN HİDROLİK DEĞİŞKEN DEBİLİ AXIAL PİSTONLU POMPALAR



BASINÇ DUYARLI PİSTONLU POMPALAR

Kod	Debi cm ³ / dev.	Basınç Bar
AR 10FR 01	10	12-210
AR 16FR 01	16	12-210
AR 22FR 01	22	12-210

YÜK DUYARLI PİSTONLU POMPALAR

Kod	Debi cm ³ / dev.	Basınç Bar
V 15HL	15	20-250
V 23HL	23	20-250

BASINÇ DUYARLI PİSTONLU POMPALAR

Kod	Debi cm ³ / dev.	Basınç Bar
V 15A	15	20-250
V 18A	18	20-250
V 23A	23	20-250
V 38A	38	20-250
V 42A	42	20-250
V 50A	50	20-210
V 70A	70	20-210

YÜK DUYARLI PİSTONLU POMPALAR

Kod	Debi cm ³ / dev.	Basınç Bar
AR 16FR HL	16	12-210
AR 22FR HL	22	12-210

WINMAN WA10V SERİSİ PİSTONLU POMPALAR

WINMAN DFLR SERİSİ PİSTONLU POMPALAR

Kod	cm ³	Regülasyon	KW	Düz Milli	Frezeli Milli	\$/Adet
WA 10 VO	28	DFLR 31R Pistonlu Pompa Open Circuit	5,50	1.633,62		
WA 10 VO	45	DFLR 31R Pistonlu Pompa Open Circuit	11,00	1.768,17		
WA 10 VO	71	DFLR 31R Pistonlu Pompa Open Circuit	22,00	2.037,90		
WA 10 VO	100	DFLR 31R Pistonlu Pompa Open Circuit	30,00	3.384,10		
WA 10 VO	140	DFLR 31R Pistonlu Pompa Open Circuit	37,00	4.553,40		

TİP: WA10V SERİSİ

WINMAN DR SERİSİ PİSTONLU POMPALAR

Kod	cm ³	Regülasyon
WA 10 VO	28	DR 31R Pistonlu Pompa Open Circuit
WA 10 VO	45	DR 31R Pistonlu Pompa Open Circuit
WA 10 VO	71	DR 31R Pistonlu Pompa Open Circuit
WA 10 VO	100	DR 31R Pistonlu Pompa Open Circuit

WINMAN DFR SERİSİ PİSTONLU POMPALAR

Kod	cm ³	Regülasyon
WA 10 VO	28	DFR 31R Pistonlu Pompa Open Circuit
WA 10 VO	45	DFR 31R Pistonlu Pompa Open Circuit
WA 10 VO	71	DFR 31R Pistonlu Pompa Open Circuit
WA 10 VO	100	DFR 31R Pistonlu Pompa Open Circuit



WINMAN HİDROLİK GÜÇ REGÜLASYONLU PİSTONLU POMPALAR



GÜÇ REGÜLASYONLU PİSTONLU POMPALAR

Kod	Çalışma Basıncı	Max. Basınç	Elektrik Motoru	Debi cm ³	
PV 016-PHB	70-350	420	4 KW	16	
PV 032-PHD	70-350	420	7,5 KW	32	
PV 063-PHF	70-350	420	15 KW	63	
PV 071-PHH	70-350	420	22 KW	71	

WINMAN SABİT DEBİLİ PİSTONLU POMPALAR



HİDROLİK PİSTONLU POMPALAR

Kod	Debi cm ³ / dev.	Max. Basınç Bar	Axial Sürekli Hız (max.)	
BB 80	80	350	2000	

HİDROLİK PİSTONLU MOTORLAR

Kod	Debi cm ³ / dev.	Max. Basınç Bar	Axial Sürekli Hız (max.)	
MB 60	63	350	2200	
MB 80	80	350	2000	

WINMAN HİDROLİK DÖKÜM GÖVDE DİŞLİ POMPALAR



ISO FLANŞLI

Kod	Debi cm ³ / dev.	Max. Basınç Bar	Axial Sürekli Hız (max.)	
BRT 35-61	61	290	1800	
BRT 35-82	82	210	1800	



UNI FLANŞLI

Kod	Debi cm ³ / dev.	Max. Basınç Bar	Axial Sürekli Hız (max.)	
BRT 34-43	43	290	1800	
BRT 34-61	61	240	1800	
BRT 34-82	82	210	1800	

WINMAN DİŞLİ AKIŞ BÖLÜCÜLER



Kod	Özellik	cm ³	Kademe	
213 L05-2	Emniyetli	2,13	2	
424 L05-2	Emniyetli	4,24	2	
06 L05-2	Emniyetsiz	6	2	
08 L05-2	Emniyetsiz	8	2	
11 L05-2	Emniyetsiz	11	2	
14 L05-2	Emniyetsiz	14	2	
17 L05-2	Emniyetsiz	17	2	
25 L05-2	Emniyetsiz	25	2	
213 L05-4	Emniyetli	2,13	4	
318 L05-4	Emniyetli	3,18	4	

WINMAN ALÜMİNYUM DİŞLİ POMPALAR

WINMAN POWERPACK POMPALARI

Kod	Dönüş Yönü		Debi cm ³ / dev.	Max.Basınç Bar
	Sağ	Sol		
0 PF 0.5 L	R	L	0.5	250
0 PF 0.75 L	R	L	0.75	250
1 PF 1.1 L	R	L	1.1	250
1 PF 1.3 L	R	L	1.3	250
1 PF 1.6L	R	L	1.6	250
1 PF 2.1 L	R	L	2.1	250
1 PF 2.7 L	R	L	2.7	250
1 PF 3.2 L	R	L	3.2	250
1 PF 3.7 L	R	L	3.7	250
1 PF 4.2 L	R	L	4.2	250
1 PF 5.8 L	R	L	5.8	200
1 PF 8.0 L	R	L	8.0	200



WINMAN GRUP 0 SERİSİ POMPALAR

Kod	Dönüş Yönü		Debi cm ³ / dev.	Max.Basınç Bar
	Sağ	Sol		
0 APF 0.16	R	L	0,16	250
0 APF 0.25	R	L	0,25	250
0 APF 0.50	R	L	0,50	250
0 APF 0.75	R	L	0,75	250
0 APF 1.25	R	L	1,25	250
0 APF 1.50	R	L	1,50	250
0 APF 1.75	R	L	1,75	250
0 APF 2.00	R	L	2,00	250



WINMAN GRUP 1 SERİSİ POMPALAR

Kod	Dönüş Yönü		Debi cm ³ / dev.	Max.Basınç Bar
	Sağ	Sol		
1 PF 1.1 F	R	L	1.1	250
1 PF 1.3 F	R	L	1.3	250
1 PF 1.6 F	R	L	1.6	250
1 PF 1.8 F	R	L	1.8	250
1 PF 2.1 F	R	L	2.1	250
1 PF 2.7 F	R	L	2.7	250
1 PF 3.2 F	R	L	3.2	250
1 PF 3.7 F	R	L	3.7	250
1 PF 4.2 F	R	L	4.2	250
1 PF 4.8 F	R	L	4.8	250
1 PF 5.8 F	R	L	5.8	200
1 PF 8.0 F	R	L	8.0	200



WINMAN GRUP 2 SERİSİ POMPALAR

Kod	Dönüş Yönü		Debi cm ³ / dev.	Max.Basınç Bar
	Sağ	Sol		
2AP 4 F	R	L	4	250
2AP 6 F	R	L	6	250
2AP 8 F	R	L	8	250
2AP 10 F	R	L	10	250
2AP 12 F	R	L	12	250
2AP 14 F	R	L	14	250
2AP 16 F	R	L	16	250
2AP 20 F	R	L	20	250
2AP 23 F	R	L	23	250
2AP 28 F	R	L	28	200
2AP 25 F	R	L	25	250



WINMAN ALÜMİNYUM DİŞLİ POMPALAR



WINMAN GRUP 3 SERİSİ POMPALAR

Kod	Dönüş Yönü		Debi cm ³ / dev.	Max.Basınç Bar
	Sağ	Sol		
3PF 26 F	R	L	26	250
3PF 36 F	R	L	36	250
3PF 39 F	R	L	39	250
3PF 43 F	R	L	43	250
3PF 51 F	R	L	51	200

WINMAN TANDEME UYGUN ALÜMİNYUM DİŞLİ POMPALAR

GRUP 1 TANDEME UYGUN POMPALAR / SAĞ DÖNÜŞLÜ



Kod	Debi cm ³ / dev.	Max.Basınç Bar
1PF 1, 1 F-C	1,1	250
1PF 1, 3 F-C	1,3	250
1PF 1,6 F-C	1,6	250
1PF 1,8 F-C	1,8	250
1PF 2,1 F-C	2,1	250
1PF 2,7 F-C	2,7	250
1PF 3,2 F-C	3,2	250
1PF 3,7 F-C	3,7	250
1PF 4,2 F-C	4,2	250
1PF 4,8 F-C	4,8	250
1PF 5,8 F-C	5,8	250

GRUP 2 TANDEME UYGUN POMPALAR / SAĞ DÖNÜŞLÜ

Kod	Debi cm ³ / dev.	Max.Basınç Bar
2PF 4F-C	4	250
2PF 6F-C	6	250
2PF 8F-C	8	250
2PF 10F-C	10	250
2PF 12F-C	12	250
2PF 14F-C	14	250
2PF 16F-C	16	250
2PF 20F-C	20	250
2PF 23F-C	23	250
2PF 28F-C	28	250
2PF 32F-C	32	250

GRUP 3 TANDEME UYGUN POMPALAR / SAĞ DÖNÜŞLÜ

Kod	Debi cm ³ / dev.	Max.Basınç Bar
3PF 36 F-C	36	250
3PF 39 F-C	39	250
3PF 43 F-C	43	250
3PF 51 F-C	51	250

Sola dönlü pompalar için bilgi alınız.

WINMAN TANDEME UYGUN ALÜMİNYUM DİŞLİ POMPALAR

TANDEM KİTLERİ

Kod	Açıklama
1PF + 1PF	Tandem Kiti
2PF + 1PF	Tandem Kiti
2PF + 2PF	Tandem Kiti
3PF + 1PF	Tandem Kiti
3PF + 2PF	Tandem Kiti
3PF + 3PF	Tandem Kiti



GRUP 1 TANDEM KİTLİ POMPA (SAĞ DÖNÜŞLÜ)

Kod	Debi cm ³ / dev.	Max.Basınç Bar
1PF 1,1 F-C-T	1,1	180
1PF 1,3 F-C-T	1,3	180
1PF 1,6 F-C-T	1,6	180
1PF 1,8 F-C-T	1,8	180
1 PF 2,1 F-C-T	2,1	180
1 PF 2,7 F-C-T	2,7	180
1 PF 3,2 F-C-T	3,2	180
1 PF 3,7 F-C-T	3,7	180
1 PF 4,2 F-C-T	4,2	180
1 PF 4,8 F-C-T	4,8	180
1 PF 5,8 F-C-T	5,8	130



GRUP 2 TANDEM KİTLİ POMPA (SAĞ DÖNÜŞLÜ)

Kod	Debi cm ³ / dev.	Max.Basınç Bar
2PF 4F-C-T	4	180
2PF 6F-C-T	6	180
2PF 8F-C-T	8	180
2PF 10F-C-T	10	180
2PF 12F-C-T	12	180
2PF 16F-C-T	16	180
2PF 20F-C-T	20	180
2PF 23F-C-T	23	150
2PF 28F-C-T	28	130



WINMAN ALÜMİNYUM DİŞLİ MOTORLAR

GRUP 2 DİŞLİ HİDROMOTORLAR

Kod	Debi cm ³ / dev.	Çıkış Torku Nm.	Max.Basınç Bar	Devir dev./dk
2AMF4F	4	10,30	250	3500
2AMF6F	6	15,50	250	3500
2AMF8F	8	20,60	250	3500
2AMF10F	10	25,80	250	3500
2AMF12F	12	30,00	250	3500
2AMF14F	14	36,10	250	3500
2AMF16F	16	41,30	250	3500
2AMF18F	18	46,40	250	3500
2AMF20F	20	51,60	250	3500
2AMF23F	23	59,30	250	3500
2AMF25F	25	64,50	250	3500



WINMAN DİREKSİYON KONTROL ÜNİTELERİ

WINMAN 101 SERİSİ DİREKSİYON ÜNİTESİ



Kod	Açıklama	Port	İletim Hacmi /cm ³	Çalışma Debisi	Çalışma Basıncı
102362	W101-50	1/2"	50	5	175
101869	W101-80	1/2"	80	8	175
101870	W101-100	1/2"	100	10	175
101871	W101-125	1/2"	125	12,5	175
133138	W101-160	1/2"	160	16	175
101873	W101-200	1/2"	200	20	175
133137	W101-250	1/2"	250	25	175
121821	W101-315	1/2"	315	31,5	175
121589	W101-400	1/2"	400	40	175

WINMAN 101 T SERİSİ DİREKSİYON ÜNİTESİ LOAD SENSING

Kod	Açıklama	Port	İletim Hacmi /cm ³	Çalışma Debisi	Çalışma Basıncı
135006-5-T	W101 T-50	1/2"	50	5	175
122291-5-T	W101 T-80	1/2"	80	8	175
122290-5-T	W101 T-100	1/2"	100	10	175
122378-5-T	W101 T-125	1/2"	125	12,5	175
121755-5-T	W101 T-160	1/2"	160	16	175
122881-5-T	W101 T-200	1/2"	200	20	175
129675-5-T	W101 T-250	1/2"	250	25	175
122195-5-T	W101 T-315	1/2"	315	31,5	175
136759-5-T	W101 T-400	1/2"	400	40	175

WINMAN HİDROMOTORLAR

WINMAN W10 (MM) SERİSİ HİDROMOTOR



Kod	W10 Muadil	Mil Çapı	İletim Hacmi cm ³	Max. Debi lt	Max. Hız d/dak	Tork /Nm		KW		Basıncı /Nm	
						Norm	Max.	Norm	Max.	Norm	Max.
135849-10	W10-8	Ø 16	8,2	16	1950	11	15	1,8	2,6	140	200
147042-10	W10-12	Ø 16	12,9	20	1550	16	23	2,4	3,2	140	200
122914-10	W10-20	Ø 16	19,9	20	1000	25	35	2,4	3,2	140	200
122916-10	W10-32	Ø 16	31,6	20	630	40	57	2,4	3,2	140	160
127284-10	W10-40	Ø 16	39,8	20	500	45	70	2,2	3,2	140	160
150046-10	W10-40	Ø 16	39,8	20	400	46	88	1,8	3,2	140	160

WINMAN V11 (P) SERİSİ HİDROMOTOR



Kod	W11 Muadil	Mil Çapı	İletim Hacmi cm ³	Max. Debi lt	Max. Hız d/dak	Tork /Nm		Basıncı /Nm	
						Norm	Max.	Norm	Max.
110473-11	W11-0080	Ø 25	50	45	858	74	86	125	140
110474-11	W11-0082	Ø 25	80	69	720	124	141	125	140
110475-11	W11-0083	Ø 25	100	69	671	155	176	125	140
110476-11	W11-008a	Ø 25	125	69	548	194	221	125	140
110477-11	W11-0084	Ø 25	160	69	426	227	260	125	140
110478-11	W11-0085	Ø 25	200	69	341	282	318	110	140
110479-11	W11-0086	Ø 25	250	69	282	302	383	100	140
110480-11	W11-0087	Ø 25	315	69	210	365	406	90	140
110481-11	W11-0088	Ø 25	400	69	173	456	521	90	140

WINMAN HİDROMOTORLAR

WINMAN V21 (R) SERİSİ HİDROMOTOR

Kod	W21 Muadil	Mil Çapı	İletim Hacmi cm ³	Max. Debi lt	Max. Hız d/dak	Tork /Nm		Basınç /Bar	
						Norm	Max.	Norm	Max.
110453-21	W21-0080	Ø 25	50	45	863	89	108	140	170
110454-21	W21-0082	Ø 25	80	68	766	142	172	140	170
110455-21	W21-0083	Ø 25	100	68	646	178	216	140	170
110456-21	W21-008a	Ø 25	125	68	516	223	270	140	170
110457-21	W21-0084	Ø 25	160	68	404	285	346	140	170
110458-21	W21-0085	Ø 25	200	68	323	318	382	125	150
110459-21	W21-0086	Ø 25	250	68	258	350	413	110	130
110460-21	W21-0087	Ø 25	315	68	205	360	400	90	110
110451-21	W21-0088	Ø 25	400	68	162	418	464	90	100



WINMAN V51 (S) SERİSİ HİDROMOTOR

Kod	W51 Muadil	Mil Çapı	İletim Hacmi cm ³	Max. Debi lt	Max. Hız d/dak	Tork /Nm		Basınç /Bar	
						Norm	Max.	Norm	Max.
110462-51	W51-0241	Ø 32	80	85	956	178	285	175	280
110463-51	W51-0242	Ø 32	100	95	855	223	356	175	280
110464-51	W51-0243	Ø 32	125	95	700	278	445	175	280
110465-51	W51-0244	Ø 32	160	115	660	356	509	175	250
110466-51	W51-0245	Ø 32	200	115	529	445	636	175	250
110467-51	W51-0246	Ø 32	250	115	423	557	755	175	250
110468-51	W51-0247	Ø 32	305	115	347	580	763	150	210
110469-51	W51-0248	Ø 32	400	130	308	715	840	150	175
151686-51	W51-0249	Ø 32	500	130	246	720	880	120	150
146649-51	W51-0250	Ø 32	565						



Kod	W81 Muadil	Mil Çapı	İletim Hacmi cm ³	Max. Debi lt	Max. Hız d/dak	Tork /Nm		Basınç /Bar	
						Norm	Max.	Norm	Max.
186764	W81 -200	Ø32	203	75	366	400	651	140	200
186765	W81-250	Ø32	260	75	290	500	790	140	200
186766	W81-315	Ø32	316	75	236	600	980	140	200
186767	W81-400	Ø32	406	75	183	705	1092	125	190
186768	W81-500	Ø32	490	75	155	670	1170	100	160

WINMAN V61 (T) SERİSİ HİDROMOTOR

Kod	W61 Muadil	Mil Çapı	İletim Hacmi cm ³	Max. Debi lt	Max. Hız d/dak	Tork /Nm		Basınç /Bar	
						Norm	Max.	Norm	Max.
122898-61	W61-0041	Ø 40	195	170	170	572	852	205	310
144431-61	W61-0042	Ø 40	245	210	210	733	1176	205	310
110470-61	W61-0043	Ø 40	310	225	225	928	1356	205	310
110471-61	W61-0044	Ø 40	395	225	225	1156	1633	205	310
110472-61	W61-0045	Ø 40	490	225	225	1213	1878	170	275
144415-61	W61-0046	Ø 40	625	225	225	1331	1368	140	170
122709-61	W61-0047	Ø 40	800	225	275	1378	1645	120	140



WINMAN W SERİSİ HİDROMOTORLAR

WINMAN WBMV (V) SERİSİ HİDROMOTOR



Kod	WBMV Muadil	Mil Çapı	İletim Hacmi cm ³	Max. Debi lt	Max. Hız d/dak	Tork /Nm		Basınç /Bar	
						Norm	Max.	Norm	Max.
122536	WBMV-00315	Ø 50	333	200	510	920	1110	200	240
121895	WBMV-00400	Ø 50	419	240	500	1180	1410	200	240
122059	WBMV-00500	Ø 50	518	240	400	1460	1760	200	240
135005	WBMV-00630	Ø 50	666	240	320	1660	1940	180	210
133918	WBMV-00800	Ø 50	801	240	250	1880	2110	160	180

ORBIT HİDROMOTORLAR

Kod	Danfoss Muadil Kodları	Açıklama
W11-037d	OMP 40	Hidromotor
110473,11	W11-32	Hidromotor
Kod	Danfoss Muadil Kodları	Açıklama
WB21-0080	OMR 50	Frenli Hidromotor
WB21-0082	OMR 80	Frenli Hidromotor
Kod	Danfoss Muadil Kodları	Açıklama
WPW-0116-80	OMPW 80	Hidromotor
WPW-0116-100	OMPW 100	Hidromotor
WPW-0116-200	OMPW 200	Hidromotor
Kod	Açıklama	
W21	Yedek Frezeli Mil	

WINMAN YAĞLAMA ÜNİTE VE FİTINGLERİ



Yağlama Ünitesi	Voltaj	Tank Kapasite	Kontrol	Max. Basınç Bar	Volume Cm3
WESG 01-01-B-1	220V	2 LT	PLC	15	130
Manuel Yağlama	Tank Kapasite	Çıkış Yönü	Çıkış Ölçüsü		
Manuel Yağlama Pompası	600 cc	Sağ	Ø6		
Kod	Dağıtıcı	Giriş Ölçüsü	Çıkış Ölçüsü		
A-5-6-4	5'li	Ø6	Ø4		
A-6-6-4	6'li	Ø6	Ø4		
A-7-6-4	7'li	Ø6	Ø4		
A-8-6-4	8'li	Ø6	Ø4		
A-9-6-4	9'lu	Ø6	Ø4		
A-10-6-4	10'lu	Ø6	Ø4		
Kod	Ayarlı Dağıtıcı	Giriş Ölçüsü	Çıkış Ölçüsü		
B-2-6-4	2'lü	Ø6	Ø4		
B-3-6-4	3'lü	Ø6	Ø4		
B-5-6-4	5'li	Ø6	Ø4		
B-9-6-4	9'lu	Ø6	Ø4		
Kod	Açıklama	Giriş Ölçüsü	\$/Adet		
PA-4	Sıkıştırma Burcu	Ø4	0,84		
PA-6	Sıkıştırma Burcu	Ø6	0,98		
PB-6	Yüksük	Ø6	0,52		
Kod	Açıklama	Giriş Ölçüsü	Çıkış Ölçüsü		
PD 402	Düz Adaptör	1/4"	M8X1		
PD 601	Düz Adaptör	1/8"	M10X1		
PD 602	Düz Adaptör	1/4"	M10X1		
PD 603	Düz Adaptör	3/8"	M10X1		
PD 610	Düz Adaptör	M10X1	M10X1		
PD 408	Düz Adaptör	M8X1	M8X1		

WINMAN HAVALI HİDROLİK YAĞ SOĞUTUCULARI

WHE HAVALI SOĞUTUCULAR

Kod	Voltaj	Kcal/h	Bar	Lt/dk
WHE 2010	220V AC	1300	25	40

Kod	Voltaj	Kcal/h	Bar	Lt/dk
WHE 2015	380V AC	6,000	25	80
WHE 2015	220V AC	6,000	25	80
WHE 2015	24V DC	6,000	25	80
WHE 2015	12V DC	6,000	25	80

Kod	Voltaj	Kcal/h	Bar	Lt/dk
WHE 2020	380V AC	6,500	25	90
WHE 2020	220V AC	6,500	25	90
WHE 2020	24V DC	6,500	25	90
WHE 2020	12V DC	6,500	25	90

Kod	Voltaj	Kcal/h	Bar	Lt/dk
WHE 2024	380V AC	12,000	25	130
WHE 2024	220V AC	12,000	25	130
WHE 2024	24V DC	12,000	25	130
WHE 2024	12V DC	12,000	25	130

Kod	Voltaj	Kcal/h	Bar	Lt/dk
WHE 2030	380V AC	20,000	25	130
WHE 2030	220V AC	20,000	25	130
WHE 2030	24V DC	20,000	25	130
WHE 2030	12V DC	20,000	25	130

Kod	Voltaj	Kcal/h	Bar	Lt/dk
WHE 2040	380V AC	25,000	25	140
WHE 2040	220V AC	25,000	25	140
WHE 2040	24V DC	25,000	25	140
WHE 2040	12V DC	25,000	25	140

Kod	Voltaj	Kcal/h	Bar	Lt/dk
WHE 2050	380V AC	40,000	25	190
WHE 2050	220V AC	40,000	25	190
WHE 2050	24V DC	40,000	25	190
WHE 2050	12V DC	40,000	25	190

CNC SOĞUTUCU

Kod	Voltaj	Kcal/h	Bar	Lt/dk
Mini 608-CA	220V AC	1,050	10	10

MİKSER SOĞUTUCULAR

Kod	Voltaj
HPA 12 TK 15 12V DC	Mikser Soğutucu
HPA 12 TK 15 24V DC	Mikser Soğutucu



WINMAN HAVALI HİDROLİK YAĞ SOĞUTUCULARI

RADYATÖR GÖVDELERİ

Kod	Açıklama
WHE 2010	Alüminyum Gövdeler
WHE 2015	Alüminyum Gövdeler
WHE 2020	Alüminyum Gövdeler
WHE 2024	Alüminyum Gövdeler
WHE 2030	Alüminyum Gövdeler
WHE 2040	Alüminyum Gövdeler
WHE 2050	Alüminyum Gövdeler
HPA 12	Alüminyum Gövdeler
AL 608	Alüminyum Gövdeler

SOĞUTUCU FANLARI



Kod	Voltaj	Açıklama
225	24V DC	2015-2020 Serisi için
280	24V DC	2024 Serisi için
305	24V DC	2030 Serisi için
385	24V DC	2040 Serisi için
280x2	24V DC	2050 Serisi için (2 Fanlı)

Kod	Voltaj	Açıklama
225	12V DC	2015-2020 Serisi için
280	12V DC	2024 Serisi için
305	12V DC	2030 Serisi için
385	12V DC	2040 Serisi için
280x2	12V DC	2050 Serisi için (2 Fanlı)

Kod	Voltaj	Açıklama
200	220V AC	2015-2020 Serisi için
250	220V AC	2024 Serisi için
300	220V AC	2030 Serisi için
400	220V AC	2040 Serisi için
450	220V AC	2050 Serisi için
	220V AC	AL 608



Kod	Voltaj	Açıklama
200	380V AC	2015-2020 Serisi için
250	380V AC	2024 Serisi için
300	380V AC	2030 Serisi için
400	380V AC	2040 Serisi için
450	380V AC	2050 Serisi için

TERMOSTAT

Derece	Açıklama
Tc1-G1/2"-50-60°C	Sabit Termostat

WINMAN SULU HİDROLİK YAĞ SOĞUTUCULARI



WINMAN WWCE SULU SOĞUTUCULAR

Kod	Yağ Debisi Aralığı (L/min)	Kapasite (Kcal/h)	
WWCE 80-4	10-35	1300-3300	
WWCE 80-5	20-60	2300-4200	
WWCE 80-6	25-60	3300-5100	
WWCE 80-7	30-60	3300-5800	
WWCE 80-8	35-60	3350-6500	
WWCE 80-9	35-70	4600-6850	
WWCE 80-10	60-75	6100-7200	
WWCE 80-11	60-80	6250-7800	
WWCE 80-12	60-85	6400-8400	
WWCE 130-6	25-60	3300-5100	
WWCE 130-7	30-60	3300-5800	
WWCE 130-8	35-60	3350-6500	
WWCE 130-9	35-70	4600-6850	
WWCE 130-10	60-75	6100-7200	
WWCE 130-11	60-80	6250-7800	
WWCE 130-13	30-85	6400-11000	
WWCE 130-14	30-85	6700-13000	
WWCE 130-15	30-85	7100-15000	
WWCE 130-17	30-113	7400-17000	
WWCE 130-18	30-113	8000-18000	
WWCE 130-19	30-113	8600-19500	
WWCE 130-21	30-113	9200-21500	
WWCE 130-26	35-125	11300-26000	
WWCE 150-14	30-85	6700-13000	
WWCE 150-18	30-113	8000-18000	
WWCE 150-26	35-125	11300-26000	
WWCE 150-30	35-125	12700-30000	
WWCE 150-34	40-150	14500-34500	
WWCE 150-38	40-150	18500-39000	
WWCE 150-42	35-170	14000-31000	
WWCE 155-40	35-170	14000-31000	
WWCE 155-50	35-190	17000-35000	
WWCE 155-60	40-220	20000-45000	

WINMAN VAPU-VDPU SERİLERİ POWERPACK HİDROLİK ÜNİTELER

02 SERİSİ

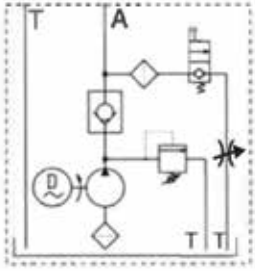

08 SERİSİ

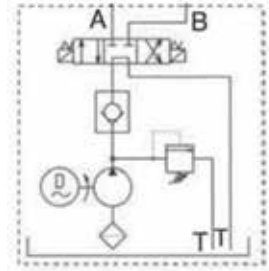

02 SERİSİ TEK ETKİLİ 380V AC

Devir	Pompa cm ³ / dev.	Depo Lt.	KW	
2800	0,50; 0,75 1,10; 1,30;1,60 2,20;1,70 3,20;3,70 4,20;5,80 8,00	1,7;2,8 4,0 5,0 6,0 8,0 10,0 12,0	0,37	
			0,75	
			1,10	
			1,50	
			1,85	
			2,20	
1500	0,37 0,75 1,10 1,50 1,85 2,20 3,00	0,37 0,75 1,10 1,50 1,85 2,20 3,00	0,37	
			0,75	
			1,10	
			1,50	
			1,85	
			2,20	

08 SERİSİ MODÜLER 380V AC

Devir	Pompa cm ³ / dev.	Depo Lt.	KW	
2800	0,50; 0,75 1,10; 1,30;1,60 2,20;1,70 3,20;3,70 4,20;5,80 8,00	1,7;2,8 4,0 5,0 6,0 8,0 10,0 12,0	0,37	
			0,75	
			1,10	
			1,50	
			1,85	
			2,20	
1500	0,37 0,75 1,10 1,50 1,85 2,20 3,00	0,37 0,75 1,10 1,50 1,85 2,20 3,00	0,37	
			0,75	
			1,10	
			1,50	
			1,85	
			2,20	

02 SERİSİ TEK ETKİLİ 12V DC

Devir	Pompa	Depo	KW	
4200	0,50;0,75 1,10	1,7;2,8 4,0	0,80	
3400	1,30;1,60 2,10;2,70	5,0 6,0	1,10	
2950	3,20;3,70 4,20;5,80	8,0 10,0	1,60	
2300	8,00	12,0	2,60	

08 SERİSİ MODÜLER 12V DC

Devir	Pompa	Depo	KW	
4200	0,50;0,75 1,10	1,7;2,8 4,0	0,80	
8400	1,30;1,60 2,10;2,70	5,0 6,0	1,10	
2950	3,20;3,70 4,20;5,80	8,0 10,0	1,60	
2300	8,00	12,0	2,60	

02 SERİSİ TEK ETKİLİ 24V DC

Devir	Pompa	Depo	KW	
4200	0,50;0,75 1,10	1,7;2,8 4,0	0,80	
3400	1,30;1,60 2,10;2,70	5,0 6,0	1,10	
3100	3,20;3,70 4,20;5,80	8,0 10,0	2,20	
2300	8,00	12,0	1,60	

08 SERİSİ MODÜLER 24V DC

Devir	Pompa	Depo	KW	
4200	0,50;0,75 1,10	1,7;2,8 4,0	0,80	
8400	1,30;1,60 2,10;2,70	5,0 6,0	1,10	
3100	3,20;3,70 4,20;5,80	8,0 10,0	2,20	
2300	8,00	12,0	1,60	

Not:

- Üniteler maksimum 8 lt. depoludur. Daha büyük depo talebi için fiyat farkı alınacaktır. 8 lt. depo fiyatı esas alınıp aradaki fiyat farkı ilave edilir.
- 02 serisi tek etkili powerpack boşaltma popetleri 24VD'dir. Diğer voltajlar için fiyat farkı alınmaktadır.
- 08 serisi modüler powerpacklerde solenoid valf fiyata dahil değildir.

WINMAN VAPU-VDPU SERİLERİ POWERPACK HİDROLİK ÜNİTELER



01 SERİSİ

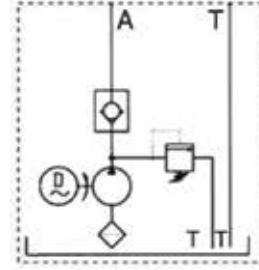

01 SERİSİ P - T ÇIKIŞLI 380V AC

Devir	Pompa cm ³ / dev.	Depo Lt.	KW
2800	0,50; 0,75 1,10; 1,30;1,60 2,20;1,70 3,20;3,70 4,20;5,80 8,00	1,7;2,8 4,0 5,0 6,0 8,0 10,0 12,0	0,37
			0,75
			1,10
			1,50
			1,85
			2,20
1500			3,00
			0,37
			0,75
			1,10
			1,50
			1,85
			2,20
			3,00

WINMAN Powerpack Pompası	Bar
OPF-0,50	SOL 250
OPF-0,75	SOL 250
1PF-1,1	SOL 250
1PF-1,30	SOL 250
1PF-1,60	SOL 250
1PF-2,10	SOL 250
1PF-2,70	SOL 250
1PF-3,20	SOL 250
1PF-3,70	SOL 250
1PF-4,20	SOL 250
1PF-5,80	SOL 250
1PF-8,00	SOL 250

01 SERİSİ P - T ÇIKIŞLI 12V DC

Devir	Pompa	Depo	KW
4200	0,50;0,75 1,10	1,7;2,8 4,0	0,80
3400	1,30;1,60 2,10;2,70	5,0 6,0	1,10
2950	3,20;3,70 4,20;5,80	8,0 10,0	1,60
2300	8,00	12,0	2,60

WINMAN DEPO LT.

Çelik Tank
1,7 Yatay
3 Yatay
4 Yatay
5 Yatay
6 Yatay
8 Yatay
10 Yatay
12 Yatay
15 Yatay
20 Yatay
20 Dik
30 Yatay

01 SERİSİ P - T ÇIKIŞLI 24V DC

Devir	Pompa	Depo	KW
4200	0,50;0,75 1,10	1,7;2,8 4,0	0,80
3400	1,30;1,60 2,10;2,70	5,0 6,0	1,10
3100	3,20;3,70 4,20;5,80	8,0 10,0	2,20
2300	8,00	12,0	1,60

Ürün Kodu
MB12-CMC NG6 VALF ARA PLEYTİ
MB12-CMC NG6 VALF ARA YÜKSELTME PLEYTİ 24mm
MB12 -CMC NG6 VALF ARA YÜKSELTME PLEYTİ 50mm
MB12-CMC NG6 VALF PLEYTİ MANOMETRELİ
STARTER 12 / 24V DC
KİLİTLEMELİ ARA BLOK

WINMAN BASINÇ FİLTRELERİ



Kod	OMT Muadil Kodu	Ölçü	Filtrasyon Micron	Debi Lt./Dk	Basınç Bar
894061	HPM281	1/2"	10	35	420
894062	HPM282	3/4"	10	55	420
894063	HPM283	3/4"	10	70	420
894064	HPM421	1"	10	80	420
894065	HPM422	1"	10	135	420
894066	HPM622	1 1/4"	10	300	420

FİLTRE ELEMANI

Kod	Debi Lt./Dk	Filtrasyon Micron
CHP 281	35	10
CHP 282	55	10
CHP 283	70	10
CHP 421	80	10
CHP 422	135	10
CHP 622	300	10



Kod	Ölçü	Basınç Bar	Filtrasyon Micron	Debi Lt./Dk
HMM 282	3/4"	220	10	55
HMM 421	3/4"	220	10	80
HMM 422	1"	220	10	135
HMM 281	3/4"	220	10	55

Kod	Ölçü
DV 500	1/2" Mekanik Kirlilik Göstergesi
DE 500	1/2" Elektro İndikor Kirlilik Göstergesi

WINMAN DÖNÜŞ FİLTRELERİ



DALDIRMA TİPİ

Kod	OMT Muadil Kodu	Ölçü	Filtrasyon Micron	Debi Lt./Dk
604067	OMTF 091	1/2"	25	40
604068	OMTF 111	3/4"	25	80
604069	OMTF 112	1"	25	100
604070	OMTF 171	1 1/4"	25	214
604071	OMTF 222	1 1/2"	25	350
604072	OMTF 224	2"	25	500

HAT TİPİ

Kod	Debi Lt./Dk	Filtrasyon Micron
OMTI 05	3/4"	25
OMTI 10	1 1/4"	25

WINMAN DÖNÜŞ FİLTRELERİ

WINMAN DÖNÜŞ FİLTRE ELEMANLARI

Kod	Debi Lt./Dk	Filtrasyon Micron	
CR 091	40	25	
CR 091	40	10	
CR 111	80	25	
CR 111	80	10	
CR 112	100	25	
CR 112	100	10	
CR 171	214	25	
CR 171	214	10	
CR 222	350	25	
CR 224	350	25	



WINMAN BASINÇ ŞALTERLERİ



Not: Ürün soket ile sevk edilmektedir. Fiyatlarımıza soket fiyatı dahildir.

Kod	Basınç Aralığı	Max. Sistem Basıncı Pmax	Gövde	Mekanik Bağlantı Tipi	Elektrik Bağlantı Tipi	Çıkış Sinyali	
W16 A3 T1 2,5 Z1	0...2,5 bar	6 bar	Paslanmaz 316 L	G1/4"	T1 DIN 43650-A Geniş Soket 30x30	Z1 4...20mA	
W16 A3 T1 6 Z1	0...6 bar	15 bar					
W16 A3 T1 10 Z1	0...10 bar	30 bar					
W16 A3 T1 16 Z1	0...16 bar	45 bar					
W16 A3 T1 25 Z1	0...25 bar	75 bar					
W16 A3 T1 40 Z1	0...40 bar	100 bar					
W16 A3 T1 60 Z1	0...60 bar	130 bar					
W16 A3 T1 100 Z1	0...100 bar	250 bar					
W16 A3 T1 160 Z1	0...160 bar	350 bar					
W16 A3 T1 250 Z1	0...250 bar	600 bar					
W16 A3 T1 315 Z1	0...315 bar	700 bar					
W16 A3 T1 400 Z1	0...400 bar	700 bar					
W16 A3 T1 600 Z1	0...600 bar	1050 bar					

Kod	Basınç Aralığı	Max. Sistem Basıncı Pmax	Gövde	Mekanik Bağlantı Tipi	Elektrik Bağlantı Tipi	Çıkış Sinyali	
W16 A3 T1 2,5 Z2	0...2,5 bar	6 bar	Paslanmaz 316 L	G1/4"	T1 DIN 43650-A Geniş Soket 30x30	Z2 0...10 V	
W16 A3 T1 6 Z2	0...6 bar	15 bar					
W16 A3 T1 10 Z2	0...10 bar	30 bar					
W16 A3 T1 16 Z2	0...16 bar	45 bar					
W16 A3 T1 25 Z2	0...25 bar	75 bar					
W16 A3 T1 40 Z2	0...40 bar	100 bar					
W16 A3 T1 60 Z2	0...60 bar	130 bar					
W16 A3 T1 100 Z2	0...100 bar	250 bar					
W16 A3 T1 160 Z2	0...160 bar	350 bar					
W16 A3 T1 250 Z2	0...250 bar	600 bar					
W16 A3 T1 315 Z2	0...315 bar	700 bar					
W16 A3 T1 400 Z2	0...400 bar	700 bar					
W16 A3 T1 600 Z2	0...600 bar	1050 bar					

WINMAN BASINÇ ŞALTERLERİ



Kod	Basınç Aralığı	Mekanik Bağlantı Şekli	Elektrik Bağlantı Şekli	
WLP A3 070	7...70 bar	G1/4"	NO/NC CONNECTION DIN 43650-A	
WLP A3 160	10...160 bar			
WLP A3 300	20...300 bar			
WLP A3 400	20...400 bar			
WLP A3 600	50...600 bar			

Not: Ürün elektrik bağlantı soketi ile sevk edilmektedir. Fiyata Soket dahildir.



Kod	Basınç Aralığı	Mekanik Bağlantı Şekli	Elektrik Bağlantı Şekli	
WLPM A3 070	7...70 bar	G1/4"	NO/NC CONNECTION DIN 43650-A	
WLPM A3 160	10...160 bar			
WLPM A3 300	20...300 bar			
WLPM A3 400	20...400 bar			
WLPM A3 600	50...600 bar			

Not: Ürün elektrik bağlantı soketi ve manometre ile sevk edilmektedir, ürünlerin tümü fiyata dahildir. Manometresiz ve soketsiz ürün için fiyat isteyiniz.



Kod	Basınç Aralığı	Mekanik Bağlantı Şekli	Elektrik Bağlantı Şekli	
WLP A2 070	7...70 bar	Slide Flange	NO/NC CONNECTION DIN 43650-A	
WLP A2 160	10...160 bar			
WLP A2 300	20...300 bar			
WLP A2 400	20...400 bar			
WLP A2 600	50...600 bar			

Not: Ürün elektrik bağlantı soketi, sızdırmazlık contası ve bağlantı civataları ile birlikte sevk edilmektedir, ürünlerin tümü fiyata dahildir.



Kod	Basınç Aralığı	Mekanik Bağlantı Şekli	Elektrik Bağlantı Şekli	
WLP A1 070	7...70 bar	Buttom Flange	NO/NC CONNECTION DIN 43650-A	
WLP A1 160	10...160 bar			
WLP A1 300	20...300 bar			
WLP A1 400	20...400 bar			
WLP A1 600	50...600 bar			

Not: Ürün elektrik bağlantı soketi, sızdırmazlık contası ve bağlantı civataları ile birlikte sevk edilmektedir, ürünlerin tümü fiyata dahildir.

WINMAN BASINÇ ŞALTERLERİ

Kod	Basınç Aralığı	Mekanik Bağlantı Şekli	Elektrik Bağlantı Şekli
WLP A3 070	7...70 bar	G1/4"	NO/NC CONNECTION DIN 43650-A
WLP A3 160	10...160 bar		
WLP A3 300	20...300 bar		
WLP A3 400	20...400 bar		
WLP A3 600	50...600 bar		

Not: Ürün elektrik bağlantı soketi ile sevk edilmektedir. Fiyata Soket dahildir.

Kod	Basınç Aralığı	Mekanik Bağlantı Şekli	Elektrik Bağlantı Şekli
WLPM A3 070	7...70 bar	G1/4"	NO/NC CONNECTION DIN 43650-A
WLPM A3 160	10...160 bar		
WLPM A3 300	20...300 bar		
WLPM A3 400	20...400 bar		
WLPM A3 600	50...600 bar		

Not: Ürün elektrik bağlantı soketi ve manometre ile sevk edilmektedir, ürünlerin tümü fiyata dahildir. Manometresiz ve soketsiz ürün için fiyat isteyiniz.

Kod	Basınç Aralığı	Mekanik Bağlantı Şekli	Elektrik Bağlantı Şekli
WLP A2 070	7...70 bar	Slide Flange	NO/NC CONNECTION DIN 43650-A
WLP A2 160	10...160 bar		
WLP A2 300	20...300 bar		
WLP A2 400	20...400 bar		
WLP A2 600	50...600 bar		

Not: Ürün elektrik bağlantı soketi, sızdırmazlık contası ve bağlantı civataları ile birlikte sevk edilmektedir, ürünlerin tümü fiyata dahildir.

Kod	Basınç Aralığı	Mekanik Bağlantı Şekli	Elektrik Bağlantı Şekli
WLP A1 070	7...70 bar	Buttom Flange	NO/NC CONNECTION DIN 43650-A
WLP A1 160	10...160 bar		
WLP A1 300	20...300 bar		
WLP A1 400	20...400 bar		
WLP A1 600	50...600 bar		

Not: Ürün elektrik bağlantı soketi, sızdırmazlık contası ve bağlantı civataları ile birlikte sevk edilmektedir, ürünlerin tümü fiyata dahildir.



WINMAN MİNYATÜR BASINÇ ŞALTERLERİ

Not: Ürün soket ve koruyucu kılıf ile sevk edilmektedir. Fiyatlarımıza dahildir.

Kod	Basınç Aralığı	Max. Sistem Basıncı Pmax	Gövde	Mekanik Bağlantı Tipi	Elektrik Bağlantı Tipi
DS3 A3 DAC 002	0,2...2 bar	40 bar	Çelik	G1/4"	Çift Kontak NO/NC DIN 43650-A
DS3 A3 DAC 012	1...12 bar	40 bar			
DS3 A3 DAC 050	5...50 bar	600 bar			
DS3 A3 DAC 100	5...100 bar	600 bar			
DS3 A3 DAC 200	20...200 bar	600 bar			
DS3 A3 DAC 400	50...400 bar	600 bar			



Kod	Basınç Aralığı	Max. Sistem Basıncı Pmax	Gövde	Mekanik Bağlantı Tipi	Elektrik Bağlantı Tipi
DS3 A4 DAC 002	0,2...2 bar	40 bar	Çelik	G1/8"	Çift Kontak NO/NC DIN 43650-A
DS3 A4 DAC 012	1...12 bar	40 bar			
DS3 A4 DAC 050	5...50 bar	600 bar			
DS3 A4 DAC 100	5...100 bar	600 bar			
DS3 A4 DAC 200	20...200 bar	600 bar			
DS3 A4 DAC 400	50...400 bar	600 bar			



WINMAN MİNYATÜR BASINÇ ŞALTERLERİ



Kod	Basınç Aralığı	Max. Sistem Basıncı Pmax	Gövde	Mekanik Bağlantı Tipi	Elektrik Bağlantı Tipi	
DS3 A3 FAC 002	0,2...2 bar	40 bar	Çelik	G1/4"	Çift Kontakt NO/NC Fast-On Terminal	
DS3 A3 FAC 012	1...12 bar	40 bar				
DS3 A3 FAC 050	5...50 bar	600 bar				
DS3 A3 FAC 100	5...100 bar	600 bar				
DS3 A3 FAC 200	20...200 bar	600 bar				
DS3 A3 FAC 400	50...400 bar	600 bar				



Kod	Basınç Aralığı	Max. Sistem Basıncı Pmax	Gövde	Mekanik Bağlantı Tipi	Elektrik Bağlantı Tipi	
DS3 A4 FAC 002	0,2...2 bar	40 bar	Çelik	G1/8"	Çift Kontakt NO/NC Fast-On Terminal	
DS3 A4 FAC 012	1...12 bar	40 bar				
DS3 A4 FAC 050	5...50 bar	600 bar				
DS3 A4 FAC 100	5...100 bar	600 bar				
DS3 A4 FAC 200	20...200 bar	600 bar				
DS3 A4 FAC 400	50...400 bar	600 bar				



Kod	Basınç Aralığı	Max. Sistem Basıncı Pmax	Gövde	Mekanik Bağlantı Tipi	Elektrik Bağlantı Tipi	
DS3 A3 NA 002	0,2...2 bar	40 bar	Çelik	G1/4"	Tek Kontakt NA / (NO) Normalde Açık	
DS3 A3 NA 012	1...12 bar	40 bar				
DS3 A3 NA 050	5...50 bar	600 bar				
DS3 A3 NA 100	5...100 bar	600 bar				
DS3 A3 NA 200	20...200 bar	600 bar				
DS3 A3 NA 400	50...400 bar	600 bar				



Kod	Basınç Aralığı	Max. Sistem Basıncı Pmax	Gövde	Mekanik Bağlantı Tipi	Elektrik Bağlantı Tipi	
DS3 A4 NA 002	0,2...2 bar	40 bar	Çelik	G1/8"	Tek Kontakt NA / (NO) Normalde Açık	
DS3 A4 NA 012	1...12 bar	40 bar				
DS3 A4 NA 050	5...50 bar	600 bar				
DS3 A4 NA 100	5...100 bar	600 bar				
DS3 A4 NA 200	20...200 bar	600 bar				
DS3 A4 NA 400	50...400 bar	600 bar				

Not: Ürün soket ile sevk edilmektedir. Fiyatlarımıza soket fiyatı dahildir.



Kod	Basınç Aralığı	Max. Sistem Basıncı Pmax	Gövde	Mekanik Bağlantı Tipi	Elektrik Bağlantı Tipi	
DS1 A3 002	0,2...2 bar	40 bar	Çelik	G1/4"	Çift Kontakt NO/NC DIN 43650-C	
DS1 A3 012	1...12 bar	40 bar				
DS1 A3 050	5...50 bar	600 bar				
DS1 A3 100	5...100 bar	600 bar				
DS1 A3 200	20...200 bar	600 bar				
DS1 A3 400	50...400 bar	600 bar				



Kod	Basınç Aralığı	Max. Sistem Basıncı Pmax	Gövde	Mekanik Bağlantı Tipi	Elektrik Bağlantı Tipi	
DS1 A4 002	0,2...2 bar	40 bar	Çelik	G1/8"	Çift Kontakt NO/NC DIN 43650-C	
DS1 A4 012	1...12 bar	40 bar				
DS1 A4 050	5...50 bar	600 bar				
DS1 A4 100	5...100 bar	600 bar				
DS1 A4 200	20...200 bar	600 bar				
DS1 A4 400	50...400 bar	600 bar				

WINMAN SEVİYE ŞALTERLERİ

Not: Ürün bağlantı soketi ile birlikte sevk edilmektedir. Soket fiyatı fiyatlarımıza dahildir.

Kod	Boy	Boru Malzemesi	Mekanik Bağlantı	Elektrik Bağlantı	
PSS A 100	100 mm	Brass	1"	Tek Kontak NO DIN 43650-A Alt Seviye Kontrol	
PSS A 150	150 mm				
PSS A 200	200 mm				
PSS A 250	250 mm				
PSS A 300	300 mm				
PSS A 400	400 mm				
PSS A 500	500 mm				
PSS A 600	600 mm				
PSS A 700	700 mm				
PSS A 800	800 mm				
PSS A 900	900 mm				
PSS A 1000	1000 mm				



WINMAN HİDROLİK SİLİNDİR AKSESUARLARI

KAYNAK MONTAJLI MANDA GÖZLÜ ARKA KULAK

Kod	Açıklama	
GK20DO	ARKA KULAK	
GK25DO	ARKA KULAK	
GK30DO	ARKA KULAK	
GK35DO	ARKA KULAK	
GK40DO	ARKA KULAK	
GK50DO	ARKA KULAK	
GK60DO	ARKA KULAK	
GK70DO	ARKA KULAK	
GK80DO	ARKA KULAK	



KAYNAK MONTAJLI MANDA GÖZLÜ KULAK

Kod	Açıklama	
GF20DO	ARKA KULAK	
GF25DO	ARKA KULAK	
GF30DO	ARKA KULAK	
GF40DO	ARKA KULAK	
GF50DO	ARKA KULAK	
GF60DO	ARKA KULAK	
GF70DO	ARKA KULAK	
GF90DO	ARKA KULAK	
GF100DO	ARKA KULAK	



MANDA GÖZLÜ ÖN KULAK

Kod	Açıklama	
GIHR-K20DO	ÖN KULAK	
GIHR-K25DO	ÖN KULAK	
GIHR-K30DO	ÖN KULAK	
GIHR-K50DO	ÖN KULAK	
GIHR-K60DO	ÖN KULAK	
GIHR-K70DO	ÖN KULAK	
GIHR-K80DO	ÖN KULAK	
GIHR-K90DO	ÖN KULAK	
GIHR-K100DO	ÖN KULAK	



WINMAN HİDROLİK VALF PLEYTLERİ



HİDROLİK VALF PLEYTLERİ ÇELİK EMNİYETSİZ

Kod	Açıklama	
NG6 Pleyt Tekli	Emniyetsiz Yandan Çıkışlı	
NG10 Pleyt Tekli	FWH-03 Emniyetsiz Yandan Çıkışlı	
NG16 Pleyt Tekli	FWH-04 Emniyetsiz Alttan Çıkışlı	
NG25 Pleyt Tekli	FWH-06 Emniyetsiz Alttan Çıkışlı	

WINMAN VALF PLEYTLERİ EMNİYETLİ

Kod	Açıklama	Kapasite Lt./Dk	Basınç Bar	
139209	NG6	30	250	
176393	NG6 T hattı yandan	30	200	
WAA-06-1-250	NG6	50	250	
VMP-35-CBE	NG6	50	350	
141368	NG10	80	250	
WDY-10-80-315	NG10	80	315	
VMP - 80 - CBE	NG10	80	350	
102354	NG6 Kör Kapak	30	250	
102355	NG10 Kör Kapak	30	250	
129663	NG6 P hattı ara blok	30	250	
129664	NG6 A-B hattı ara blok	30	250	

NG6 ALÜMİNYUM VALF PLEYTLERİ, YANDAN ÇIKIŞLI

Sipariş Kodu	NG6	Gövde	A-B Port	
167113	2'Li	Alüminyum	Yandan Çıkışlı	
189008	3'Lü	Alüminyum	Yandan Çıkışlı	
172456	4'Lü	Alüminyum	Yandan Çıkışlı	
189009	5'Li	Alüminyum	Yandan Çıkışlı	
163148	6'Li	Alüminyum	Yandan Çıkışlı	
163144	7'Li	Alüminyum	Yandan Çıkışlı	
189010	8'Li	Alüminyum	Yandan Çıkışlı	
165124	9'Lu	Alüminyum	Yandan Çıkışlı	
189011	10'Lu	Alüminyum	Yandan Çıkışlı	

NG10 ALÜMİNYUM VALF PLEYTLERİ, YANDAN ÇIKIŞLI

Sipariş Kodu	NG10	Gövde	A-B Port	
178722	2'Li	Alüminyum	Yandan Çıkışlı	
189002	3'Lü	Alüminyum	Yandan Çıkışlı	
165557	4'Lü	Alüminyum	Yandan Çıkışlı	
188982	5'Li	Alüminyum	Yandan Çıkışlı	
189003	6'Li	Alüminyum	Yandan Çıkışlı	
189004	7'Li	Alüminyum	Yandan Çıkışlı	
189005	8'Li	Alüminyum	Yandan Çıkışlı	
189006	9'Lu	Alüminyum	Yandan Çıkışlı	
189007	10'Lu	Alüminyum	Yandan Çıkışlı	



W-A-Y SERİSİ NG6 HİDROLİK VALF PLEYTLERİ

Kod	Gövde	A-B Port	
NG6 3'lü Pleyt	Metal	Yandan Çıkışlı	
NG6 4'lü Pleyt	Metal	Yandan Çıkışlı	
NG6 5'li Pleyt	Metal	Yandan Çıkışlı	
NG6 6'lı Pleyt	Metal	Yandan Çıkışlı	
NG6 7'li Pleyt	Metal	Yandan Çıkışlı	
NG6 8'li Pleyt	Metal	Yandan Çıkışlı	
NG6 9'lu Pleyt	Metal	Yandan Çıkışlı	
NG6 10'lu Pleyt	Metal	Yandan Çıkışlı	

WINMAN HİDROLİK VALF PLEYTLERİ

W-A-Y SERİSİ NG6 HİDROLİK VALF PLEYTLERİ

Kod	Gövde	A-B Port	
NG6 3'lü Pleyt	Metal	Yandan Çıkışlı	
NG6 4'lü Pleyt	Metal	Yandan Çıkışlı	
NG6 5'li Pleyt	Metal	Yandan Çıkışlı	
NG6 6'lı Pleyt	Metal	Yandan Çıkışlı	
NG6 7'li Pleyt	Metal	Yandan Çıkışlı	
NG6 8'li Pleyt	Metal	Yandan Çıkışlı	
NG6 9'lu Pleyt	Metal	Yandan Çıkışlı	
NG6 10'lu Pleyt	Metal	Yandan Çıkışlı	



NG6 HİDROLİK VALF PLEYTLERİ ÇELİK SAĞ-SOL ÇIKIŞLI DÜZ/EMNİYETSİZ

Kod	Gövde	A-B Port	
NG6 3'lü Pleyt	Metal	Sağ-Sol Çıkışlı	
NG6 4'lü Pleyt	Metal	Sağ-Sol Çıkışlı	
NG6 5'li Pleyt	Metal	Sağ-Sol Çıkışlı	
NG6 6'lı Pleyt	Metal	Sağ-Sol Çıkışlı	
NG6 7'li Pleyt	Metal	Sağ-Sol Çıkışlı	
NG6 8'li Pleyt	Metal	Sağ-Sol Çıkışlı	
NG6 10'lu Pleyt	Metal	Sağ-Sol Çıkışlı	



NG6 EMNİYET KATRIÇLİ VALF PLEYTLERİ 350 BAR

Kod	Gövde	Emniyet	A-B Port	
NG6 2'li Pleyt	Metal	35 Lt. Emn.	Yandan Çıkışlı	
NG6 3'lü Pleyt	Alüminyum	35 Lt. Emn.	Yandan Çıkışlı	
NG6 4'lü Pleyt	Metal	35 Lt. Emn.	Yandan Çıkışlı	
NG6 5'li Pleyt	Metal	35 Lt. Emn.	Yandan Çıkışlı	
NG6 6'lı Pleyt	Metal	35 Lt. Emn.	Yandan Çıkışlı	
NG6 7'li Pleyt	Metal	35 Lt. Emn.	Yandan Çıkışlı	
NG6 8'li Pleyt	Metal	35 Lt. Emn.	Yandan Çıkışlı	
NG6 9'lu Pleyt	Metal	35 Lt. Emn.	Yandan Çıkışlı	
NG6 10'lu Pleyt	Metal	35 Lt. Emn.	Yandan Çıkışlı	



NG10 HİDROLİK VALF PLEYTLERİ YANDAN ÇIKIŞLI DÜZ EMNİYETSİZ

Kod	Gövde	A-B Port	
NG10 3'lü Pleyt	Metal	Yandan Çıkışlı	
NG10 4'lü Pleyt	Metal	Yandan Çıkışlı	
NG10 5'li Pleyt	Metal	Yandan Çıkışlı	
NG10 6'lı Pleyt	Metal	Yandan Çıkışlı	
NG10 7'li Pleyt	Metal	Yandan Çıkışlı	
NG10 8'li Pleyt	Metal	Yandan Çıkışlı	



WINMAN HİDROLİK VALF PLEYTLERİ



NG6 HİDROLİK VALF PLEYTLERİ ÇELİK SAĞ-SOL ÇIKIŞLI DÜZ/EMNİYETSİZ

Kod	Gövde	A-B Port	
NG6 3'lü Pleyt	Metal	Sağ-Sol Çıkışlı	
NG6 4'lü Pleyt	Metal	Sağ-Sol Çıkışlı	
NG6 5'li Pleyt	Metal	Sağ-Sol Çıkışlı	
NG6 6'lı Pleyt	Metal	Sağ-Sol Çıkışlı	
NG6 7'li Pleyt	Metal	Sağ-Sol Çıkışlı	
NG6 8'li Pleyt	Metal	Sağ-Sol Çıkışlı	
NG6 10'lu Pleyt	Metal	Sağ-Sol Çıkışlı	



NG6 EMNİYET KATRIÇLİ VALF PLEYTLERİ 350 BAR

Kod	Gövde	Emniyet	A-B Port	
NG6 2'li Pleyt	Metal	35 Lt. Emn.	Yandan Çıkışlı	
NG6 3'lü Pleyt	Alüminyum	35 Lt. Emn.	Yandan Çıkışlı	
NG6 4'lü Pleyt	Metal	35 Lt. Emn.	Yandan Çıkışlı	
NG6 5'li Pleyt	Metal	35 Lt. Emn.	Yandan Çıkışlı	
NG6 6'lı Pleyt	Metal	35 Lt. Emn.	Yandan Çıkışlı	
NG6 7'li Pleyt	Metal	35 Lt. Emn.	Yandan Çıkışlı	
NG6 8'li Pleyt	Metal	35 Lt. Emn.	Yandan Çıkışlı	
NG6 9'lu Pleyt	Metal	35 Lt. Emn.	Yandan Çıkışlı	
NG6 10'lu Pleyt	Metal	35 Lt. Emn.	Yandan Çıkışlı	



NG10 HİDROLİK VALF PLEYTLERİ YANDAN ÇIKIŞLI DÜZ EMNİYETSİZ

Kod	Gövde	A-B Port	
NG10 3'lü Pleyt	Metal	Yandan Çıkışlı	
NG10 4'lü Pleyt	Metal	Yandan Çıkışlı	
NG10 5'li Pleyt	Metal	Yandan Çıkışlı	
NG10 6'lı Pleyt	Metal	Yandan Çıkışlı	
NG10 7'li Pleyt	Metal	Yandan Çıkışlı	
NG10 8'li Pleyt	Metal	Yandan Çıkışlı	

WINMAN DELİK KÖRLEME TAPALARI

DELİK KÖRLEME TAPASI (BİLYALI)



Kod	
Ø3	
Ø4	
Ø5	
Ø6	
Ø8	
Ø10	
Ø12	
Ø14	
Ø16	

WINMAN HİDROLİK MOBİL VALFLER

HAT TİPİ TUTMA VALFİ TEKLİ

Kod	Port	Max.Debi Lt/Dk.	Max.Basınç Bar
VBCL 380	3/8"	40	350
VBCL 120	1/2"	60	350

HAT TİPİ TUTMA VALFİ TEKLİ

Kod	Port	Max.Debi Lt/Dk.	Max.Basınç Bar
OWC/SE-38/L/X	3/8"	40	350
OWC/SE-12/L/X	1/2"	60	350
OWC/SE-34/L/X	3/4"	120	350
OWC/SE-100L/X	1"	160	350
WBC/C/SE-SE-38/L	3/8"	40	350

HAT TİPİ TUTMA VALFİ TEKLİ

Kod	Port	Max.Debi Lt/Dk.	Max.Basınç Bar
OWC/SE-100L/CC	1"	160	350

HAT TİPİ TUTMA VALFİ İKİZ

Kod	Port	Max.Debi Lt/Dk.	Max.Basınç Bar
VBCD 380	3/8"	40	350
VBCD 120	1/2"	60	350

HAT TİPİ TUTMA VALFİ İKİZ

Kod	Port	Max.Debi Lt/Dk.	Max.Basınç Bar
OWC/DE-38/L/X	3/8"	40	350
OWC/DE-12/L/X	1/2"	60	350
OWC/DE-34/L/X	3/4"	120	350
OWC/DE-100L/X	1"	160	350

HAT TİPİ TUTMA VALFİ İKİZ

Kod	Port	Max.Debi Lt/Dk.	Max.Basınç Bar
OWC/DE-34/LU/CC/X	3/4"	120	350
OWC/DE-100/LU/CC/X	1"	160	350

MODÜLER YÜK TUTMA VALFİ TEKLİ

Kod	Port	Max.Debi Lt/Dk.	Max.Basınç Bar
OWC/SE-L6-A-Y	NG6	40	350
OWC/SE-L10/A/X	NG10	60	350

MODÜLER YÜK TUTMA VALFİ İKİZ

Kod	Port	Max.Debi Lt/Dk.	Max.Basınç Bar
OWC/DE-L6-Y	NG6	30	350
OWC/DE-L10/X	NG10	80	350

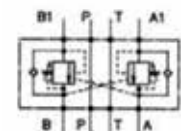
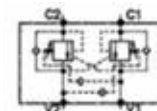
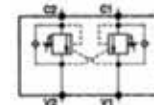
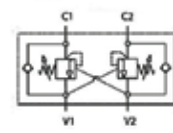
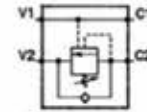
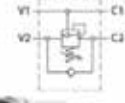

WINMAN HİDROLİK MOBİL VALFLER



HAT TİPİ TUTMA VALFİ İKİZ (KAPALI MERKEZ)

Kod	Port	Max.Debi Lt/Dk.	Max.Basınç Bar
VBCB 120	1/2"	80	350



HAT TİPİ YÜK TUTMA VALFİ (FACE TİP)

Kod	Port	Max.Debi Lt/Dk.	Max.Basınç Bar
WB/SE/FC-B04-38/PSM	3/8"	40	350

HAT TİPİ YÜK TUTMA VALFİ TEKLİ

Kod	Port	Max.Debi Lt/Dk.	Max.Basınç Bar
VBCB 380 BANJO MONTAJ	3/8"	40	350
WB/SE-38FCB-X	3/8"	40	350
WB/SE-12FCB-X	1/2"	60	350

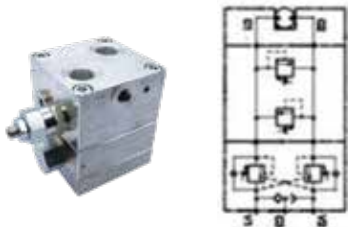

HAT TİPİ YÜK TUTMA VALFİ İKİLİ

Kod	Port	Max.Debi Lt/Dk.	Max.Basınç Bar
WB/DE-38FCB-X	3/8"	40	350
WB/DE-12FCB-X	1/2"	60	350

MOTOR TİPİ YÜK TUTMA VALFLERİ İKİZ

Kod	Port	Max.Debi Lt/Dk.	Max.Basınç Bar
WB/VS/M/DI-VFF-F-OMP-OMR	1/2" - 1/4"	60	DANFOSS



HAT TİPİ DİREK EMNİYET VALFLERİ WHEV SERİSİ

Kod	Port	Max.Debi Lt/Dk.	Max.Basınç Bar
WHEV 120	1/2"	35	315

HAT TİPİ DİREK EMNİYET VALFLERİ VMP SERİSİ

Kod	Port	Max.Debi Lt/Dk.	Max.Basınç Bar
VMP/45-X/C-12-L-SN	1/2"	45	350
VMP/80-X/C-34-L	3/4"	80	350



HAT TİPİ DİREK EMNİYET VALFLERİ VMDR SERİSİ

Kod	Port	Max.Debi Lt/Dk.	Max.Basınç Bar
VMDR 10 - 140	1/4"	20	210
VMDR 10 - 380	3/8"	20	210
VMDR 40 - 120	1/2"	40	210
VMDR 90 - 340	3/4"	80	210
VMDR 120 - 100	1"	120	210



HİDROMOTOR BAĞLANTILI İKİZ EMNİYET VALFLERİ

Kod	Ölçü	Max.Debi Lt/Dk.	Max.Basınç Bar
VDI-45-SN-FMOMP-OMR12D	OMP-OMR Montaj	45	350

WINMAN HİDROLİK MOBİL VALFLER VE KATRIÇLER

HAT TİPİ BASINÇ EMNİYET VALFLERİ İKİZ

Kod	Port	Max.Debi Lt/Dk.	Max.Basınç Bar
VMP/DI/35-38/L	3/8"	35	350
VMP/DI/35-12/L	1/2"	35	350
VMP/DI/80-34/L	3/4"	80	350

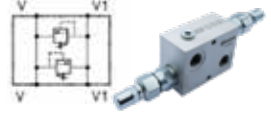

HAT TİPİ BASINÇ EMNİYET VALFLERİ İKİZ

Kod	Port	Max.Debi Lt/Dk.	Max.Basınç Bar
DCV 120	1/2"	40	350

BASINÇ SIRALAMA VALFLERİ

Kod	Port	Max.Debi Lt/Dk.	Max.Basınç Bar
VSQ/D/C-38/X	3/8"	40	350
VSQ/D/C-12/X	1/2"	60	350
VSQ/D/C-34/X	3/4"	120	350
VSQ/D/C-100/X	1"	160	350
VSQ/D/C-100/CC	1"	160	350

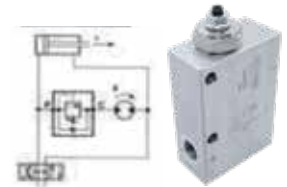

HAT TİPİ BASINÇ DÜŞÜRÜCÜ

Kod	Port	Max.Debi Lt/Dk.	Max.Basınç Bar
VRP/38-L-50	3/8"	45	50
VRP/38-L	3/8"	45	350

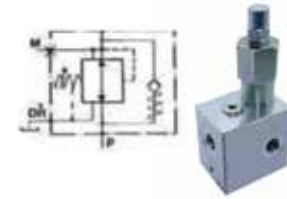

HAT TİPİ AKIŞ BÖLÜCÜ VALFLERİ QP - QE

Kod	Max.Debi - Lt./Dk.	Max.Basınç / Bar
VDF-38-D	2 - 6	210
VDF-12-A	6,5 - 11	210
VDF-12-B	13 - 22	210
VDF-12-C	25 - 38	210
VDF-34-A	28 - 55	210
VDF-34-B	56 - 95	210
VDF-100	90 - 150	210

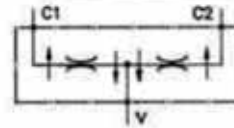

HAT TİPİ W SERİSİ AKIŞ BÖLÜCÜ VALFLERİ

Kod	Max.Debi - Lt./Dk.	Max.Basınç / Bar
WFD-05-60	30-60	250
WFD-05-70	43-74	250
WFD-05-90	53-90	250
WFD-06-90	90	250
WFD-06-110	110	250
WFD-06-150	150	250
WFD-06-190	194	250

HAT TİPİ PLATFORM VALFİ (BOBİN HARIÇ)

Kod	Port	Max.Debi - Lt./Dk.
VC/DC-14-C-VMP/20	1/4"	20
VC/DC-38-C-VMP/20	3/8"	40
VC/DC-12R-E-S-M	1/2"	60
VC/DC-34-14	3/4"	80



WINMAN HİDROLİK MOBİL VALFLER VE KATRIÇLER

VEYA VALFİ

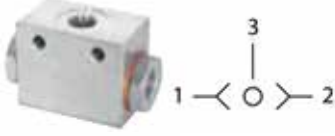

Kod	Port	Max.Debi Lt/Dk.	Max.Basınç Bar
VUSF 140	1/4"	20	350

TANDEM SIFIRLAMA VALFLERİ HAT TİPİ

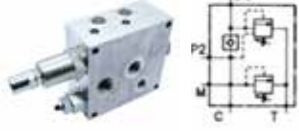

Kod	Port	Max.Debi Lt/Dk.	Max.Basınç Bar
VD/34-12-38-14	3/4"	90	350

TANDEM SIFIRLAMA VALFLERİ (MODÜLER)



Kod	Port	Max.Debi Lt/Dk.	Max.Basınç Bar
VD/CTP-03	NG 6	60	350
VD/CTP-05	NG 10	90	350
VDP/L16/FC7-34L-F/A	NG 16	120	350

3 YOLLU BASINÇ DUYARLI HIZ AYAR VALFLERİ



Kod	Port	Max.Debi Lt/Dk.	Max.Basınç Bar
VRF/CN/3V-C-38/L-Y	3/8"	30	350
VRF/CN/3V-C-12/L-Y	1/2"	45	350

3 YOLLU AKIŞ BÖLÜCÜ VALFLER QP - QE



Kod	Ölçü	Max.Debi Lt/Dk.	Max.Basınç Bar
VRF/3V-38	3/8"	35-55	350
VRF/3V-12	1/2"	55-90	350
VRF/3V-34	3/4"	90-150	350

HİDROLİK KIRICI VALFLER (BOBİN DAHİL) QP - QE



Kod	Ölçü	Max.Debi Lt/Dk.	Max.Basınç Bar
VRF/3V+VMP+VMS-100/X	1"	150-250	350
VRF/3V+VMS-114/X	1 1/4"	250-400	350

KATRIÇ ÇEKVALFLER



Kod	Ölçü	Max.Debi Lt/Dk.	Max.Basınç Bar
WCVHO.S08	SAE 08	50	420
WCVCO.S10.GY	SAE 10	80	420
WVCO.S12	SAE 12	120	420
WVCO.S16	SAE 16	320	420
WCVO.S20	SAE 20	400	420
VNR-C-14-38	M20x1,5	30	350
VNR-C-12-34	3/4" GAS	80	350
VNR-C-34-100	1" GAS	150	350

KATRIÇ TİPİ PİLOTLU KİLİT



Kod	Ölçü	Max.Debi Lt/Dk.	Max.Basınç Bar
VPR 08	3/4" - 1	15	350
WSPC 4-M18	M18 x 1,5	40	350
WSPC 4-M22	M22x1,5	60	350

WINMAN HİDROLİK KATRIÇLER

WINMAN KATRIÇ TİP DİREK KUMANDALI BASINÇ EMNİYET VALFLERİ

Kod	Açıklama	Ayar Aralığı Bar	Kavite	Debi Lt./Dk.	
152445	WRDA-01-06	15-60	T-162A	45	
152446	WRDA-01-21	35-210	T-162A	45	
152447	WRDA-01-42	80-420	T-162A	45	

152448	WRDA-02-10	20-105	T-10A	100	
152449	WRDA-02-21	35-210	T-10A	100	
152450	WRDA-02-42	80-420	T-10A	100	

152451	WRDA-03-10	20-105	T-3A	200	
152452	WRDA-03-21	35-210	T-3A	200	
152453	WRDA-03-42	50-420	T-3A	200	

152454	WRDA-06-10	20-105	T-16A	380	
152455	WRDA-06-21	35-210	T-16A	380	
152456	WRDA-06-42	50-420	T-16A	380	

152457	WRDA-10-10	20-105	T-18A	760	
152458	WRDA-10-21	35-210	T-18A	760	
152459	WRDA-10-42	50-420	T-18A	760	

WINMAN KATRIÇ TİP PİLOT KUMANDALI BASINÇ EMNİYET VALFLERİ

Kod	Açıklama	Ayar Aralığı Bar	Kavite	Debi Lt./Dk.	
152460	WWRC-02-20	8-210	T-10A	100	
152461	WWRC-02-40	12-420	T-10A	100	

152462	WWRC-03-20	8-210	T-3A	200	
152463	WWRC-03-40	12-420	T-3A	200	

152464	WWRC-06-20	8-210	T-16A	380	
152465	WWRC-06-40	12-420	T-16A	380	

152466	WWRC-10-20	8-210	T-18A	760	
152467	WWRC-10-40	12-420	T-18A	760	

WINMAN KATRIÇ TİP DIŞARDAN PİLOTLU KUMANDALI BASINÇ EMNİYET VALFLERİ

Kod	Açıklama	Ayar Aralığı Bar	Kavite	Debi Lt./Dk.	\$/Adet
152468	WRA-01-10	*-100	T-163A	30	
152469	WRA-01-20	8-210	T-163A	30	
152470	WRA-01-40	12-420	T-163A	30	

152471	WRA-02-10	*-100	T-11A	60	
152472	WRA-02-20	8-210	T-11A	60	
152473	WRA-02-40	12-420	T-11A	60	

152474	WRA-03-10	*-100	T-2A	120	
152475	WRA-03-20	8-210	T-2A	120	
152476	WRA-03-40	12-420	T-2A	120	

152477	WRA-06-10	*-100	T-17A	240	
152478	WRA-06-20	8-210	T-17A	240	
152479	WRA-06-40	12-420	T-17A	240	

152480	WRA-10-10	*-100	T-19A	480	
152481	WRA-10-20	8-210	T-19A	480	
152482	WRA-10-40	12-420	T-19A	480	

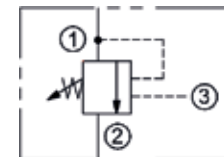
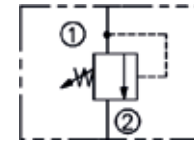
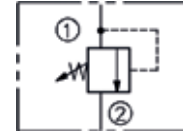

WINMAN HİDROLİK KATRIÇLER

WINMAN KATRIÇ TİP DİREK KUMANDALI BASINÇ SIRALAMA VALFLERİ ÇEKİLİ

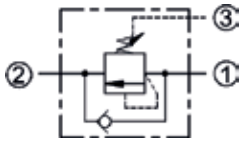

Kod	Açıklama	Ayar Aralığı Bar	Kavite	Debi Lt./Dk.	
152483	WWHC-02-05	14-55	T-11A	60	
152484	WWHC-02-20	35-210	T-11A	60	
152485	WWHC-02-30	55-315	T-11A	60	
152486	WWHC-03-05	14-55	T-2A	120	
152487	WWHC-03-20	35-210	T-2A	120	
152488	WWHC-03-30	55-315	T-2A	120	
152489	WWHC-06-05	14-55	T-17A	240	
152490	WWHC-06-20	35-210	T-17A	240	
152491	WWHC-06-30	55-315	T-17A	240	
152492	WWHC-10-05	14-55	T-19A	480	
152493	WWHC-10-20	35-210	T-19A	480	
152494	WWHC-10-30	55-315	T-19A	480	

WINMAN KATRIÇ TİP DİREK KUMANDALI BASINÇ SIRALAMA VALFLERİ

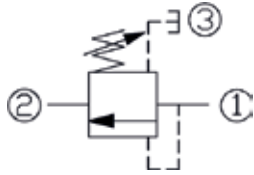

Kod	Açıklama	Ayar Aralığı Bar	Kavite	Debi Lt./Dk.	
152495	WHG-02-10	3,5-105	T-11A	60	
152496	WHG-02-21	7-210	T-11A	60	
152497	WHG-02-42	10-420	T-11A	60	
152498	WHG-03-10	3,5-105	T-2A	120	
152499	WHG-03-21	7-210	T-2A	120	
152500	WHG-03-42	10-420	T-2A	120	
152501	WHG-06-10	3,5-105	T-17A	240	
152502	WHG-06-21	7-210	T-17A	240	
152503	WHG-06-42	10-420	T-17A	240	

WINMAN KATRIÇ TİP PİLOT KUMANDALI BASINÇ DÜŞÜRME VALFLERİ

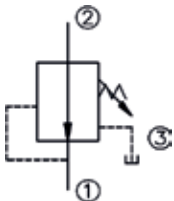

Kod	Açıklama	Ayar Aralığı Bar	Kavite	Debi Lt./Dk.	
152504	WBR-02-04	4-60	T-11A	40	
152505	WBR-02-09	4-100	T-11A	40	
152506	WBR-02-20	7-210	T-11A	40	
152507	WBR-03-04	4-60	T-2A	80	
152512	WBR-03-09	4-100	T-2A	80	
152513	WBR-03-20	7-210	T-2A	80	
152514	WBR-06-04	4-60	T-17A	160	
152515	WBR-06-09	4-100	T-17A	160	
152516	WBR-06-20	7-210	T-17A	160	
152517	WBR-06-31	10-315	T-17A	160	
152518	WBR-10-04	4-60	T-19A	320	
152519	WBR-10-09	4-100	T-19A	320	
152520	WBR-10-20	7-210	T-19A	320	

WINMAN HİDROLİK KATRIÇLER

WINMAN KATRIÇ TİP DİREK KUMANDALI BASINÇ DÜŞÜRME VALFLERİ ÇİFT GEÇİŞLİ

Kod	Açıklama	Ayar Aralığı Bar	Kavite	Debi Lt./Dk.	
152521	WGB-02-10	3,5-105	T-11A	30	
152522	WGB-02-21	35-210	T-11A	30	
152523	WGB-02-30	50-315	T-11A	30	

152524	WGB-03-10	3,5-105	T-2A	80	
152525	WGB-03-21	35-210	T-2A	80	
152526	WGB-03-30	50-315	T-2A	80	

152527	WGB-06-10	3,5-105	T-17A	160	
152528	WGB-06-21	35-210	T-17A	160	
152529	WGB-06-30	50-315	T-17A	160	

152530	WGB-10-10	3,5-105	T-19A	320	
152531	WGB-10-21	35-210	T-19A	320	
152532	WGB-10-30	50-315	T-19A	320	

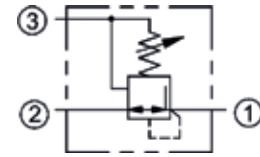

WINMAN KATRIÇ TİP PİLOT KUMANDALI BASINÇ DÜŞÜRME VALFLERİ ÇİFT GEÇİŞLİ

Kod	Açıklama	Ayar Aralığı Bar	Kavite	Debi Lt./Dk.	
152765	WRB-02-10	4-105	T-11A	40	
152768	WRB-02-21	7-210	T-11A	40	
152769	WRB-02-30	10-315	T-11A	40	

152770	WRB-03-10	4-105	T-02A	80	
152772	WRB-03-21	7-210	T-02A	80	
152773	WRB-03-30	10-315	T-02A	80	

152774	WRB-06-10	4-105	T-17A	160	
152775	WRB-06-21	7-210	T-17A	160	
152776	WRB-06-30	10-315	T-17A	160	

152777	WRB-10-10	4-105	T-19A	320	
152778	WRB-10-21	7-210	T-19A	320	
152779	WRB-10-30	10-315	T-19A	320	

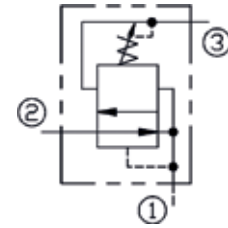

WINMAN KATRIÇ HIZ AYAR BASINÇ KOMPANZASYONLU

Kod	Açıklama	Kavite	Debi Lt./Dk.	\$/Adet
158603	WEC-10-50	T-10A	60	
158604	WEC-16-40	CS16-3S	200	
158605	WEC-20-50	CS20-3S	380	



WINMAN HİDROLİK KATRIÇLER

WINMAN KATRIÇ TİP KARŞI DENGE (COUNTER BALANCE) VALFLERİ

Kod	Açıklama	Açma Basıncı	Ayar Aralığı Bar	Kavite	Debi Lt./Dk.
152533	WCB-02-10-3A	3:1	25-105	T-11A	60
152534	WCB-02-28-3A	3:1	70-280	T-11A	60
152535	WCB-02-17-4A	4,5:1	70-175	T-11A	60
152536	WCB-02-28-4A	4,5:1	70-280	T-11A	60
163524	WCB-02-35-4A	4,5:1	140-350	T-11A	60
152537	WCB-02-17-10A	10:1	70-175	T-11A	60
163523	WCB-02-35-10A	10:1	140-350	T-11A	60
152538	WCB-02-28-1,5A	1,5:1	70-280	T-11A	60
110449	WCB-02-25-3A	3:1	25-105	T-11A	60

10-28 Serileri açma basınçları 1,8 Bar
Açma basıncı 0,3 Bar için bilgi alınız.



152539	WCB-03-10-3A	3:1	25-105	T-2A	120
152540	WCB-03-28-3A	3:1	70-280	T-2A	120
176594	WCB-03-28-10A	10:1	70-280	T-2A	120
152541	WCB-03-17-4A	4,5:1	70-175	T-2A	120
152542	WCB-03-28-4A	4,5:1	70-280	T-2A	120
152543	WCB-03-17-10A	10:1	70-175	T-2A	120
152544	WCB-03-28-1,5A	1,5:1	70-280	T-2A	120
110450	WCB-03-25-3A	3:1	25-105	T-2A	120

10-28 Serileri açma basınçları 1,8 Bar
Açma basıncı 0,3 Bar için bilgi alınız.

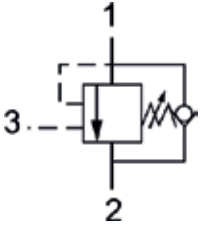

152545	WCB-06-10-3A	3:1	25-105	T-17A	240
152546	WCB-06-28-3A	3:1	70-280	T-17A	240
152547	WCB-06-17-4A	4,5:1	70-175	T-17A	240
152548	WCB-06-28-4A	4,5:1	70-280	T-17A	240
152549	WCB-06-17-10A	10:1	70-175	T-17A	240
152550	WCB-06-28-10A	10:1	70-280	T-17A	240
110452	WCB-06-25-3A	3:1	25-105	T-17A	240

10-28 Serileri açma basınçları 1,8 Bar
Açma basıncı 0,3 Bar için bilgi alınız.

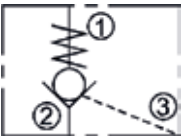

WINMAN KATRIÇ TİP PİLOT KUMANDALI ÇEKVALFLER

Kod	Açıklama	Açma Basıncı	Basıncı Bar	Kavite	Debi Lt./Dk.
152551	WWCK-01-3A-20	3:1	350	T-163A	30
152552	WWCK-02-3A	3:1	350	T-11A	60
152553	WWCK-03	3:1	350	T-2A	120
152554	WWCK-06	3:1	350	T-17A	200
152555	WWCK-10	3:1	350	T-19A	460
170029	WCXA-02-20	KAPALI (TERS)	350	T-11A	60
157372	WCXA-03-20	KAPALI (TERS)	350	T-2A	140

WINMAN BASINÇ KONTROL LOJİKLERİ

Kod	Açıklama	Açma Basıncı	Basıncı Bar	Fark Alanı	Debi Lt./Dk.		
152556	WLCV-16-B	0,5	2	4,5	315	2:1	130
152557	WLCV-25-B	0,5	2	4,5	315	2:1	350
152558	WLCV-32-B	0,5	2	4,5	315	2:1	500
152559	WLCV-40-B	0,5	2	4,5	315	2:1	850
152560	WLCV-50-B	0,5	2	4,5	315	2:1	1400
152561	WLCV-63-B	0,5	2	4,5	315	2:1	2100

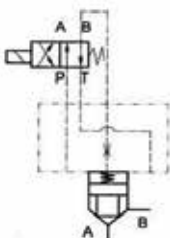

WINMAN HİDROLİK KATRIÇLER

WINMAN YÖN KONTROL LOJİKLERİ

Kod	Açıklama	Açma Basıncı	Basınç /Bar	Fark Alanı	Debi-Lt./Dk.		
152562	WLCV-16-E	0,5	2	4,5	315	2:1	130
152563	WLCV-25-E	0,5	2	4,5	315	2:1	350
152564	WLCV-32-E	0,5	2	4,5	315	2:1	500
152565	WLCV-40-E	0,5	2	4,5	315	2:1	850
152566	WLCV-50-E	0,5	2	4,5	315	2:1	1400
152567	WLCV-63-E	0,5	2	4,5	315	2:1	2100

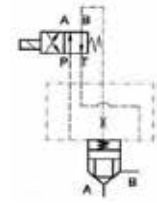

WINMAN DÜŞÜK ŞOKLU KONTROL LOJİKLERİ

Kod	Açıklama	Açma Basıncı	Basınç /Bar	Fark Alanı	Debi-Lt./Dk.		
152568	WLCV 16-D	0,5	2	4,5	315	2:1	130
152569	WLCV 25-D	0,5	2	4,5	315	2:1	350
152570	WLCV 32-D	0,5	2	4,5	315	2:1	500
152571	WLCV 40-D	0,5	2	4,5	315	2:1	850
152572	WLCV 50-D	0,5	2	4,5	315	2:1	1400
152573	WLCV 63-D	0,5	2	4,5	315	2:1	2100

WINMAN KATRIÇ TİP VEYA VALFİ

Kod	Açıklama	Çalışma Basıncı	Kavite	Debi-Lt./Dk.
152574	WWLS-02	350	T-11A	10
163204	WLSB-02	350	T-11A	10
163203	WWLS-08	350	CS08-3N	19
191872	WWLS-04	350	CS04-B3	6

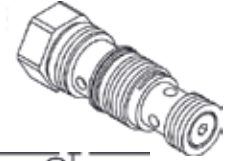

WINMAN KATRIÇ TİP ÇEKVALFLER

Kod	Açıklama	Açma Basıncı	Basınç /Bar	Kavite	Debi-Lt./Dk.
152575	WCX-01-05	0,35	350	T-162A	40
152576	WCX-01-20	2	350	T-162A	40
152577	WCX-01-50	5	350	T-162A	40
152578	WCX-02-05	0,35	350	T-13A	80
152579	WCX-02-20	2	350	T-13A	80
152580	WCX-02-50	5	350	T-13A	80
152581	WCX-03-05	0,35	350	T-5A	140
152582	WCX-03-20	2	350	T-5A	140
152583	WCX-03-50	5	350	T-5A	140
152584	WCX-06-05	0,35	350	T-16A	320
152585	WCX-06-20	2	350	T-16A	320
152586	WCX-06-50	5	350	T-16A	320
152587	WCX-10-05	0,35	350	T-18A	640
152588	WCX-10-20	2	350	T-18A	640
152589	WCX-10-50	5	350	T-18A	640

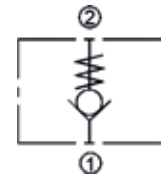

WINMAN KATRIÇ TİP ÇEKİLİ HIZ AYAR VALFLERİ

Kod	Açıklama	Basınç /Bar	Kavite	Debi-Lt./Dk.
152590	WWT-02 Çeksiz	350	T-13A	35
152591	WWT-03 Çeksiz	350	T-5A	50
152592	WWT-06 Çeksiz	350	T-16A	160
152593	WNC-01 Çekli	350	T-162A	15
152594	WNC-02 Çekli	350	T-13A	40
152595	WNC-03 Çekli	350	T-5A	80
152596	WNC-06 Çekli	350	T-16A	160

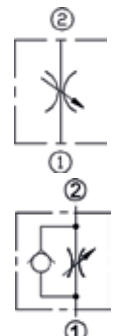
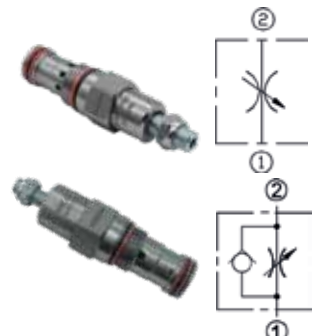

WINMAN HİDROLİK KATRIÇLER

KATRIÇ EMNİYET VALFLERİ

Kod	Port	Max.Debi Lt/dk.	Max.Basınç Bar
WRVB7.S08-N	SAE 08	25	180
WRVB7.S08-B	SAE 08	25	280
WRVB7.S08-G	SAE 08	25	350
WVB0.S09.ON.	SAE 10	25	180
WRVC0.S08.B	SAE 08	30	220
WRVD0.M20.B	M20	30	215
WRVD0.M22.B	M22	35	215
WRVC0.S09.G	3/4"-16UNF	40	350
WRVC0.S10.B	SAE 10	50	200
WRVC0.S10.G	SAE 10	50	350
WRVS0.S10.B	SAE 10	80	240
WVQ0.S10	SAE 10	120	420
WVR0.M28	M 28	250	420
WRV10.S08.B İKİLİ EMNİYET	SAE 08	30	250

KATRIÇ EMNİYET VALFLERİ VMP SERİSİ

Kod	Port	Max.Debi Lt/dk.	Max.Basınç Bar
VMP/10-G	M20x1,5	10	100
VMP/20-X-SN	3/4"-16 UNF	20	80
VMP/20-X Uzun	M18x1,5	20	350
VMP/35-X	M22x1,5	35	350
VMP/45-X-SN	M22x1,5	45	350
VMP/80-G	M24x1,5	80	350

KATRIÇ EMNİYET VALFLERİ VMD SERİSİ

Kod	Port	Max.Debi Lt/dk.	Max.Basınç Bar
VMD 10V3	SAE 08	20	350
VMD 120	M 28x1,5	120	350

HIZ AYAR KATRIÇLERİ 2/2 ÇEKİSİZ

Kod	Ölçü	Max.Debi Lt/dk.	Max.Basınç Bar
FRT	SAE 08	25	350
FRTO	SAE 08	40	350
VST/T-45-Y	M22x1.5	45	350
CF B-60	SAE 10	60	245

HIZ AYAR KATRIÇİ BASINÇ DUYARLI 2/2

Kod	Ölçü	Max.Debi Lt/dk.	Max.Basınç Bar
VSTC - 20Y	SAE 08	20	350

HIZ AYAR KATRIÇİ ÇEKİLİ 2/2

Kod	Ölçü	Max.Debi Lt/dk.	Max.Basınç Bar
VST-UD-T-20	SAE 08	20	350

HIZ AYAR KATRIÇİ 3 YOLLU

Kod	Ölçü	Max.Debi Lt/dk.	Max.Basınç Bar
VRF-CN-3V-Y	M22x1.5	45	210

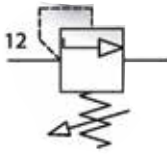
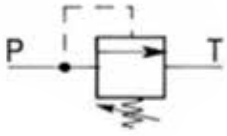

WINMAN HİDROLİK KATRIÇLER

2/2 POPET KATRIÇLERİ NORMALDE KAPALI (BOBİN HARIÇ)

Kod	Kavite	Pozisyon	Max.Debi Lt./Dk.	Bobin	Max.Basınç Bar
WVTO	SAE 08	N.C. Çift Geçişli	40	EVI 5/13	350
WVSO	SAE 08	N.C.	40	EVI 5/13	350
VEP-NC-50	SAE 10	N.C.	50	EVI 3/16	350
WVSO.S10	SAE 10	N.C.	80	EVI 5/13	350
WVTO.S10	SAE 10	N.C. Çift Geçişli	80	EVI 5/13	350
VE-NC-80	3/4" - BSPP	N.C.	80	EVI 3/14	300
VE-NC-150	1" BSPP	N.C.	150	EVI 3/14	300
WVTO.S12	SAE 12	N.C. Çift Geçişli	150	EVI 5/13	350
WVSO.S12	SAE 12	N.C.	150	EVI 5/13	350

Not: WVHO serisi sadece DC bobin ile çalışır.

2/2 POPET KATRIÇLERİ NORMALDE AÇIK (BOBİN HARIÇ)

Kod	Kavite	Pozisyon	Max.Debi Lt./Dk.	Bobin	Max.Basınç Bar
WVJO.S08	SAE 08	N.O.	40	EVI 5/13	350
WVKO.S08	SAE 08	N.O. Çift Geçişli	40	EVI 5/13	300
VEP-NA-50	SAE 10	N.O.	50	EVI 3/16	350
WVJO.S10	SAE10	N.O.	80	EVI 5/13	350
WVKO.S10	SAE 10	N.O. Çift Geçişli	80	EVI 5/13	350
VE-NA-80	3/4"-BSPP	N.O.	80	EVI 3/14	300
VE-NA-150	1" BSPP	N.O.	150	EVI 3/14	300

2/2 POPET KATRIÇLERİ NORMALDE KAPALI - MANUEL BOŞALTMALI (BOBİN HARIÇ)

Kod	Açıklama	Kavite	Pozisyon	Max.Debi Lt./Dk.	Bobin	Max.Basınç Bar
WVSO-01	Manuel Boşaltmalı	SAE 08	N.C.	40	EVI 5/13	300

2/2 POPET K ATRİÇ ÇİFT ÇEK VALFLİ (BOBİN HARIÇ)

Kod	Açıklama	Kavite	Pozisyon	Max.Debi Lt./Dk.	Bobin	Max.Basınç Bar
WVDO	Çift Çekli	SAE 08	N.C.	15	EVI 5/13	250
WVD5	Çift Çekli	SAE 08	N.C.	30	EVI 5/13	250

\$/Adet

WVSV 08-28+Bobin	Çift Çekli	SAE 08	N.C.	40	EVI 5/13	350
------------------	------------	--------	------	----	----------	-----

€/Adet

WVEO	Çift Çekli	SAE 08	N.O.	15	EVI 5/13	250
------	------------	--------	------	----	----------	-----

WVYO	Çift Çekli	SAE 08	N.O.	40	EVI 5/13	350
------	------------	--------	------	----	----------	-----

2/2 POPET GÖVDESİ

Kod	Açıklama	Kavite	Max.Basınç Bar
5.071	C-14 GAS-011-T-E Manuel boşaltmalı	SAE 08	315
5.072	C-38 GAS-011N-T-E Manuel boşaltmalı	SAE 08	315
5.233	C-12 GAS-020N-T-E Manuel boşaltmalı	SAE 10	315
5.529	C-34 GAS-102L-T-E Manuel boşaltmalı	3/4" BSPP	315
5.533	C-100GAS-011N-T-E Manuel boşaltmalı	1" BSPP	315
005.071	C-14 GAS	SAE 08	315
005.072	C-38 GAS	SAE 08	315
113156	C-34 GAS	SAE 10	250



WINMAN HİDROLİK KATRIÇLER

3/2 POPET KATRIÇLERİ (BOBİN HARIÇ)

Kod	Ölçü	Pozisyon	Max.Debi Lt./Dk.	Bobin	Max.Basınç Bar
WSVP.S08	SAE 08-2	N.O.	10	EVI 5/13	250
WSVC.S08	SAE 08-2	N.C.	10	EVI 5/13	250
WVPO.M18	M18	N.O.	7	EVI 5/13	210
VEDT-3V-50-071N	7/8" - UNF	3/2 N.O	45	EVI 5/13	300
WVIO.S10	SAE 10-2	3/2 N.C.	20	EVI 5/13	250
WVIO.S08	SAE 08-2	3/2 N.C.	10	EVI 5/13	250
WVPO.S08.2	SAE 08-2	3/2 N.C.	10	EVI 5/13	250
WVPO.S08.3	SAE 08-2	3/2 N.O.	10	EVI 5/13	250
WVPO.S08.4	SAE 08-2	3/2 N.C.	12	EVI 5/13	250

4/2 POPET KATRIÇLERİ (BOBİN HARIÇ)

Kod	Kavite	Konum	Merkez	Max.Debi Lt/dk.	Bobin	Max.Basınç Bar
WVAO.S08-A	SAE 08-3	4/2	Düz-Çapraz	12	EVI 5/13	250
WVAO.S08-B	SAE 08-3	4/2	Kapalı-Çapraz	12	EVI 5/13	250
WVAO.S08.C	SAE 08-3	4/2	Çapraz-Kapalı	12	EVI 5/13	250
WVAO.S08.D	SAE 08-3	4/2	-	12	EVI 5/13	250
WVAO.S08.E	SAE 08-3	4/2	Çapraz-Kapalı M.	12	EVI 5/13	250
WVAO.S08.F	SAE 08-3	4/2	K.M. - Düz	12	EVI 5/13	250
WVAO.S08.G	SAE 08-3	4/2	Düz-A.B.T.	12	EVI 5/13	250
WVAO.S08.H	SAE 08-3	4/2	Çapraz-Düz	12	EVI 5/13	250

Not:5/13 kare bobin kullanılmaktadır.Fiyata dahil değildir.

4/3 POPET KATRIÇLERİ (BOBİN HARIÇ)

Kod	Kavite	Konum	Merkez	Max.Debi Lt/dk.	Bobin	Max.Basınç Bar
WVBO.S08-A	SAE 08-3	4/3	K.M.	10	EVI 5/13	250
WVBO.S08-B	SAE 08-3	4/3	A.M.	10	EVI 5/13	250
WVBO.S08.C	SAE 08-3	4/3	H.M.	10	EVI 5/13	250
WVBO.S08.D	SAE 08-3	4/3	A.B.T.	10	EVI 5/13	250
WVBO.S08.E	SAE 08-3	4/3	3-4 Kapalı 2-1 Açık	10	EVI 5/13	250

Not:5/13 kare bobin kullanılmaktadır.Fiyata dahil değildir.

4/2 POPET KATRIÇLERİ (BOBİN HARIÇ)

Kod	Açıklama	Pozisyon	Bobin	Konum
SV22-42 A	T.B.	4/2	EVI 3/14	K.M. - DÜZ
SV22-42 B	T.B.	4/2	EVI 3/14	H.M. - ÇAPRAZ
SV22-42 C	T.B.	4/2	EVI 3/14	A.B.T. - DÜZ
SV22-42 F	T.B.	4/2	EVI 3/14	A.M. - ÇAPRAZ

Not:Fiyatlara bobin ve soket dahil değildir. 1 adet 26W bobin + 1 adet soket ilave edilecektir.

4/3 POPET KATRIÇLERİ (BOBİN HARIÇ)

Kod	Açıklama	Pozisyon	Bobin	Konum
SV22-43 A	Ç.B.	4/3	EVI 3/14	K.M.
SV22-43 B	Ç.B.	4/3	EVI 3/14	H.M.
SV22-43 C	Ç.B.	4/3	EVI 3/14	A.B.T.
SV22-43 F	Ç.B.	4/3	EVI 3/14	A.M.

Not:Fiyatlara bobin ve soket dahil değildir. 1 adet 26W bobin + 1 adet soket ilave edilecektir.

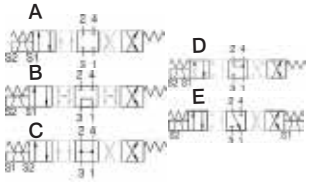
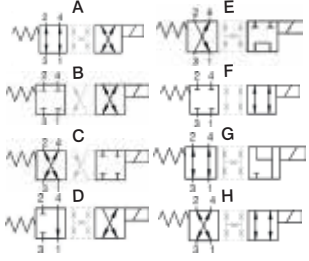

WINMAN HİDROLİK BOBİN VE AKSESUARLARI

WINMAN SV SERİSİ VALF BOBİNLERİ

Kod	
SV22-12V DC	
SV22-24V DC	
SV22-220V RC	



POPET VALF BOBİNLERİ

Kod	Açıklama
WCSOA.24	KARE EVI 5/13 24V DC Bobin
WCSOA.220	KARE EVI 5/13 220V AC Bobin
WCSOA.220.RAC	KARE EVI 5/13 220R AC Bobin
WCSOA.12	KARE EVI 5/13 12V DC Bobin
WCSOA.110	KARE EVI 5/13 110V AC Bobin



Kod	Açıklama
C37.D.012.DC	YUV EVI 3/14 12V DC Bobin
C37.D.024.DC	YUV EVI 3/14 24V DC Bobin
C37.D.11050	YUV EVI 3/14 110V AC Bobin
C37.D.22050	YUV EVI 3/14 220V AC Bobin
C36.D.22050R AC	YUV EVI 3/14 220R AC Bobin
C36.D.110R AC	YUV EVI 3/14 110R AC Bobin



Kod	Açıklama
C38.D.012.DC	YUV EVI 3/16 12V DC Bobin
C38.D.024 DC	YUV EVI 3/16 24V DC Bobin
C38.D.110R AC	YUV EVI 3/16 110R AC Bobin
C38.D.220R AC	YUV EVI 3/16 220R AC Bobin
C38.D.110V AC	YUV EVI 3/14 110V AC Bobin



GENİŞ SOKET

Kod	
DIN Kare Soket	
DIN R AC Kare Soket	



GENİŞ SOKET LEDLİ

Kod	Açıklama
FW YEDEK LEDLİ SOKET	DC 12
FW YEDEK LEDLİ SOKET	DC 24
FW YEDEK LEDLİ SOKET	AC 110
FW YEDEK LEDLİ SOKET	AC 220



GENİŞ KARTLI SOKET

Kod	Açıklama	Özellik
WCPR.1.0	Oransal Kartlı Soket	Kartlı



WINMAN HİDROLİK ORANSAL KATRIÇLER



WINMAN HİDROLİK ORANSAL KATRIÇ HIZ AYAR KATRIÇİ

Kod	Açıklama	Özellik	Kavite	
WJ 0320	Oransal Hız Ayar	30Lt / 250 bar	SAE 08	
WCR1D.24	Bobin	24V DC	-	
WCPR.1.0	Oransal Kartlı Soket	Kartlı	-	

WINMAN HİDROLİK ORANSAL BASINÇ EMNİYET KATRIÇLERİ

Kod	Açıklama	Özellik	Kavite	
WVR 10-25	Oransal Emniyet+Bobin	120Lt/250 bar	SAE 10	
WVR 10-10	Oransal Emniyet+Bobin	120Lt/140 bar	-	
COS1-D2	Oransal Valf Bobini	24V-DCI	-	

WINMAN HİDROLİK KOMPANENTLER

HİDROLİK ÇEKİLİ HIZ AYAR VALFLERİ (PANO TİPİ)



Kod	Ölçü	Max.Debi Lt./Dk.	Max.Basınç Bar	
STUF 140	1/4"	15	400	
STUF 380	3/8"	30	400	
STUF 120	1/2"	50	400	
STUF 340	3/4"	85	400	
STUF 100	1"	150	400	
STUF Sıkma Somunu	1/4"	-	-	

HİDROLİK ÇEKSİZ HIZ AYAR VALFLERİ (PANO TİPİ)



Kod	Ölçü	Max.Debi Lt./Dk.	Max.Basınç Bar	
STBF 140	1/4"	15	400	
STBF 380	3/8"	30	400	
STBF 120	1/2"	45	400	
STBF 340	3/4"	80	400	
STBF 100	1"	150	400	
STBF Sıkma Somunu				

HİDROLİK ÇEKİLİ BASINÇ KOMPANZASYONLU HIZ AYAR VALFLERİ



Kod	Ölçü	Max.Debi Lt./Dk.	Max.Basınç Bar	
VRC 140	1/4"	10	250	
VRC 380	3/8"	18	250	
VRC 120	1/2"	33	250	

WINMAN HİDROLİK KOMPANENTLER

HİDROLİK ÇEKİLİ HIZ AYAR VALFLERİ VOLAN TİP

Kod	Ölçü	Max.Debi Lt./Dk.	Max.Basınc Bar
VURF 140	1/4"	15	350
VURF 380	3/8"	30	350
VURF 120	1/2"	50	350
VURF 340	3/4"	85	350



HORTUM PATLAMA KATRIÇİ VE KOVANI

Kod	Ölçü	Max.Debi Lt./Dk.	Max.Basınc Bar
VUB A 140	25	1/4" Katrıç	350
VUB A 380	50	3/8" Katrıç	350
VUB A 120	80	1/2" Katrıç	350
VUB A 340	150	3/4" Katrıç	350
VUB A 100	180	1" Katrıç	350
VUB A 140 M/F	25	1/4" Kovan	350
VUB A 380 M/F	50	3/8" Kovan	350
VUB A 120 M/F	80	1/2" Kovan	350
VUB A 340 M/F	150	3/4" Kovan	350
VUB A 100 M/F	180	1" Kovan	350



HİDROLİK ÇEKVALFLER

Kod	Ölçü	Max.Debi Lt./Dk.	Max.Basınc Bar
VUR 140	1/4"	15	350
VUR 380	3/8"	30	350
VUR 120	1/2"	50	320
VUR 120-3BAR	1/2"	50	320
VUR 120-6BAR	1/2"	50	320
VUR 340	3/4"	90	300
VUR 340-3BAR	3/4"	90	300
VUR 340-6BAR	3/4"	90	300
VUR 100	1"	150	250
VUR 100-3BAR	1"	150	250
VUR 100-6BAR	1"	150	250
VUR 114	1 1/4"	200	250
VUR 114-6BAR	1 1/4"	200	250
VUR 112	1 1/2"	300	210
VUN 38	3/8"	30	500
VUN 120	1/2"	50	500



HİDROLİK KATRIÇ TİP ÇEKVALFLER

Kod	Ölçü	Max.Debi Lt./Dk.	Max.Basınc Bar
VUI 140	1/4" BSPP	20	350
VUI 380	3/8" BSPP	30	350
VUI 120	1/2" BSPP	50	350
VUI 340	3/4" BSPP	80	350

WINMAN HİDROLİK KOMPANENTLER



HİDROLİK HAT TİPİ KİLİTLEME (BORU TİP)

Kod	Ölçü	Max.Debi Lt./Dk.	Max.Basınç Bar
VRPE 140	1/4"	25	350
VRPE 380	3/8"	40	350
VRPE 120	1/2"	60	350
VRPE 340	3/4"	90	350
VRPE 100	1"	150	300



HİDROLİK HAT TİPİ KİLİTLEME (TEKLI)

Kod	Ölçü	Max.Debi Lt./Dk.	Max.Basınç Bar
VRSE 140	1/4"	15	320
VRSE 380	3/8"	35	320
VRSE 120	1/2"	45	300
VRSE 340	3/4"	70	300

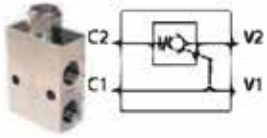

HİDROLİK HAT TİPİ KİLİTLEME (TEKLI)

Kod	Ölçü	Max.Debi Lt./Dk.	Max.Basınç Bar
VRP 120	1/2"	50	350

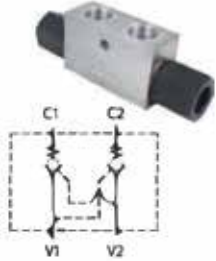

HİDROLİK HAT TİPİ KİLİTLEME (İKİZ)

Kod	Ölçü	Max.Debi Lt./Dk.	Max.Basınç Bar
VRDE 140	1/4"	15	320
VRDE 380	3/8"	35	320
VRDE 120	1/2"	45	300
VRDE 340	3/4"	70	280
3.360.J VNR-50-DE	3/8"	35	350



HAT TİPİ KİLİTLEME (İKİZ)

Kod	Ölçü	Max.Debi Lt./Dk.	Max.Basınç Bar
VNR/C/SO/DE-38/J	3/8"	35	350
VNR/C/SO/DE-12/J	1/2"	45	350



Kod	Ölçü	Max.Debi Lt./Dk.	Max.Basınç Bar
HYVBPDE-A	1/4"	-	350



HİDROLİK KARTRİÇ TİP ÇEKVALF

Kod	Ölçü	Max.Debi Lt./Dk.	Max.Basınç Bar
VUP 140	1/4" BSPP	20	500
VUP 380	3/8" BSPP	35	500
VUP 120	1/2" BSPP	60	500

WINMAN HİDROLİK KOMPANENTLER

HAT TİPİ KİLİTLEME (İKİZ FACE TİP)

Kod	Ölçü	Max.Debi Lt/Dk.	Max.Basınç Bar
VRDF 380	3/8"	35	350
VRDF 120	1/2"	50	350

HAT TİPİ KİLİTLEME (BANJO TİP)

Kod	Ölçü	Max.Debi Lt/Dk.	Max.Basınç Bar
VNR-C-SO-DE-50-SP-FCB-38-J	3/8"	40	350
VNR-C-SO-DE-50-SP-FCB-12-J	1/2"	50	350

HİDROLİK TEK ETKİLİ EL POMPASI

Kod	Kapasite cm ³	Max.Basınç Bar
PMS 12	12	380
PMS 25	25	350
PMS 45	45	280

HİDROLİK ÇİFT ETKİLİ EL POMPASI

Kod	Kapasite cm ³	Max.Basınç Bar
PMI 12	12	380
PMI 25	25	350
PMI 45	45	280

ALÜMİNYUM EL POMPASI TANKLARI

Kod	Kapasite Lt
TNA 1	1
TNA 2	2
TNA 3	3
TNA 4	4
TNA 5	5

METAL EL POMPASI TANKLARI

Kod	Kapasite Lt
TNK1	1
TNK2	2
TNK3	3
TNK5	5

MANUEL ACİL DURUM BUTON VALF (2/2 N.C. ÇİFT ÇEKİLİ)

Kod	Ölçü	Max.Debi Lt./Dk.	Max.Basınç Bar
VEM 6	3/4 - 16UNF	30	320
VEM 10	7/8 - 14UNF	50	320

HAT TİPİ REJENERATİF VALFİ

Kod	Port	Max.Debi Lt./Dk.	Max. Basınç Bar
VR 60SE	1/2"	80	350

HAT TİPİ REJENERATİF VALFİ

Kod	Port	Max.Debi Lt./Dk.	Max. Basınç Bar
VR-CRR-CTP3	NG6	30	350



WINMAN HİDROLİK KOMPANENTLER

DÖNER ELEMANLAR / DÜZ



Kod	Ölçü	Dönüş Hızı Dev./Dk	Max.Debi Lt./Dk.	Max.Basınç Bar
GGIL 140	1/4"	212	25	400
GGIL 380	3/8"	173	35	400
GGIL 120	1/2"	160	60	300
GGIL 340	3/4"	120	100	300
GGIL 100	1"	100	180	300

DÖNER ELEMANLAR / 90° DİRSEK



Kod	Ölçü	Dönüş Hızı Dev./Dk	Max.Debi Lt./Dk.	Max.Basınç Bar
GG 90140	1/4"	212	25	400
GG 90380	3/8"	173	35	400
GG 90120	1/2"	160	60	300
GG 90340	3/4"	120	100	300
GG 90100	1"	100	180	300

MANOMETRE KORUMA VALFİ HAT TİPİ / DÜZ



Kod	Ölçü	Max.Basınç Bar
SOV 1400	1/4"	400

MANOMETRE KORUMA VALFİ HAT TİPİ / DİRSEK



Kod	Ölçü	Max.Basınç Bar
SOV 1490	1/4"	400

PİMLİ STROK SONU VALFİ

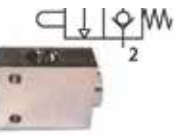

Kod	Ölçü	Max.Debi Lt./Dk.	Max.Basınç Bar
FCM 140N	1/4"	25	350
FCM 380N	3/8"	40	350
FCM 120N	1/2"	60	300

EL POMPASI POPET TİPİ



Kod	Ölçü	Kapasite cm	Max.Basınç Bar
PME 6	SAE 08	2	200
PME 10	SAE 10/2	10	200

EL KUMANDALI ÇİFT ÇEKLİ POPET

Kod	Ölçü	Kapasite cm	Max.Basınç Bar
CM 6	SAE 08	25	320

HİDROLİK ÜÇ YOLLU KÜRESEL VANA (ORTA KONUM P-1-2 AÇIK)

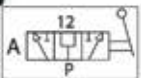

Kod	Ölçü	Max.Debi Lt./Dk.	Max.Basınç Bar
DDF 3380-A	3/8"	60	350
DDF 3120-A	1/2"	90	350
DDF 3340-A	3/4"	120	350
DDF 3100-A	1"	200	300

WINMAN HİDROLİK KOMPANENTLER

HİDROLİK DÖRT YOLLU KÜRESEL VANA (4/3 ORTA KONUM KAPALI)

Kod	Ölçü	Max.Debi Lt./Dk.	Max.Basınç Bar
IDF 4140-A	1/4"	60	350



HİDROLİK ALTI YOLLU KÜRESEL VANA (3/3 ORTA KONUM KAPALI)

Kod	Ölçü	Max.Debi Lt./Dk.	Max.Basınç Bar
DDF6 120-B	1/2"	90+90	350

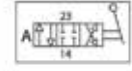

HİDROLİK KÜRESEL VANA 3 YOLLU

Kod	Ölçü	Özellik	Max.Basınç Bar
KHB 3K	1/4"	3 Yollu	315
KHB 3K	3/8"	3 Yollu	315
KHB 3K	1/2"	3 Yollu	315
KHB 3K	3/4"	3 Yollu	315
KHB 3K	1"	3 Yollu	315
KHB 3K	1 1/4"	3 Yollu	315



HİDROLİK KÜRESEL VANA 2 YOLLU

Kod	Ölçü	Özellik	Max.Basınç Bar
KHB	1/4"	2 Yollu	500
KHB	3/8"	2 Yollu	500
KHB	1/2"	2 Yollu	400
KHB	3/4"	2 Yollu	315
KHB	1"	2 Yollu	315
KHB	1 1/4"	2 Yollu	315
KHB	1 1/2"	2 Yollu	315
KHB	2"	2 Yollu	315
KHB	1 1/2"	2 Yollu Redüksiyon Geçişli	315
KHB	2"	2 Yollu Redüksiyon Geçişli	315



HİDROLİK KÜRESEL VANA 2 YOLLU 304 PASLANMAZ

Kod	Ölçü	Özellik	Max.Basınç Bar
KHB	1/4"	304 Kalite 2 Yollu	500
KHB	3/8"	304 Kalite 2 Yollu	500
KHB	1/2"	304 Kalite 2 Yollu	500
KHB	3/4"	304 Kalite 2 Yollu	315
KHB	1"	304 Kalite 2 Yollu	315
KHB	1 1/4"	304 Kalite 2 Yollu	315
KHB	1 1/2"	304 Kalite 2 Yollu	315
KHB	2"	304 Kalite 2 Yollu	315



HİDROLİK KÜRESEL VANA 2 YOLLU BORU BAĞLANTILI

Kod	Ölçü	Özellik
KHB 08 LR	KHB 10SR	2 Yollu
KHB 10 LR	KHB 12SR	2 Yollu
KHB 12 LR	-	2 Yollu
-	KHB 16SR	2 Yollu
-	KHB 20SR	2 Yollu
-	KHB 25SR	2 Yollu
-	KHB 30SR	2 Yollu

HİDROLİK PLEYT TİPİ KÜRESEL VANA 2 YOLLU

Kod	Ölçü	Özellik
KHP 06	6	Pleyt Tipi
KHP 10	10	Pleyt Tipi

NOT: Küresel Vanaların Sızdırmalık Elemanı POM'dur.
180

AMİ HİDROLİK KUMANDA KOLLARI



Kod	Açıklama	Bar	Lt./Dk.	
3	Tekli 3/8" Monoblok	300	40	

Kod	Açıklama	Bar	Lt./Dk.	
253	3'lü 1/2" Monoblok	350	50	
256	6'lı 1/2" Monoblok	350	50	

Kod	Açıklama	Bar	Lt./Dk.	
702 (3/4")	2'li 3/4" Monoblok	220	120	

Kod	Açıklama	Bar	Lt./Dk.	
702 (1")	2'li 1" Monoblok	220	120	

HİDROLİK BASINÇ YÜKSELTİCİLER

HİDROLİK BASINÇ YÜKSELTİCİLER

Kod	Max.Giriş Debisi (Lt./Dk.)	Çıkış Debisi Q ₁	Çıkış Debisi Q ₂	Max.Giriş Basıncı (bar)	Max. Çıkış Basıncı (bar)	
MP - M - 4.0	35	4	2.4	200	800	
MP - T - 2.0	8	0.8	0.2	200	400	
MP - T - 3.4	15	2.2	0.5	200	680	
MP - T - 4.0	14	1.8	0.4	200	800	
MP - T - 5.0	14	1.4	0.3	160	800	
MP - 2000 - 10	12	0.7	0.2	200	2000	

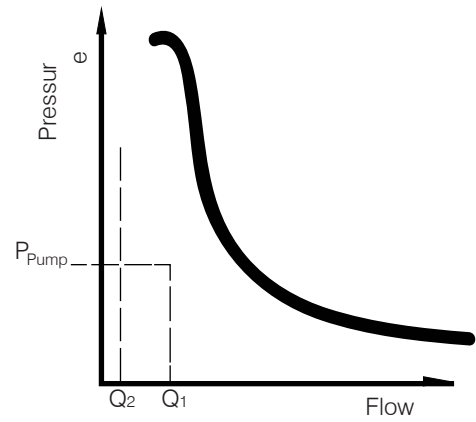

WINMAN HORTUMLAR

R1 TEK KAT TELLİ HORTUM

Kod	Özellik
1 SN 1/4"	DIN-EN 853 1/4" Hidrolik Hortum
1 SN 5/16"	DIN-EN 853 5/16" Hidrolik Hortum
1 SN 3/8"	DIN-EN 853 3/8" Hidrolik Hortum
1 SN 1/2"	DIN-EN 853 1/2" Hidrolik Hortum
1 SN 5/8"	DIN-EN 853 5/8" Hidrolik Hortum
1 SN 3/4"	DIN-EN 853 3/4" Hidrolik Hortum
1 SN 1"	DIN-EN 853 1 Hidrolik Hortum
1 SN 1 1/4"	DIN-EN 853 1 1/4" Hidrolik Hortum
1 SN 2"	DIN-EN 853 2" Hidrolik Hortum



WINMAN ULTIMATE DIN EN 853 1SN (BLUE)

Kod	Özellik
ULTIMATE 1SN	1/4"
ULTIMATE 1SN	3/8"
ULTIMATE 1SN	5/8"
ULTIMATE 1SN	3/4"
ULTIMATE 1SN	1"
ULTIMATE 1SN	1 1/4"
ULTIMATE 1SN	1 1/2"
ULTIMATE 1SN	2"

R2 2 KAT TELLİ HİDROLİK HORTUM

Kod	Özellik
2 SN 1/4"	DIN-EN 853 1/4" Hidrolik Hortum
2 SN 5/16"	DIN-EN 853 5/16" Hidrolik Hortum
2 SN 3/8"	DIN-EN 853 3/8" Hidrolik Hortum
2 SN 1/2"	DIN-EN 853 1/2" Hidrolik Hortum
2 SN 5/8"	DIN-EN 853 5/8" Hidrolik Hortum
2 SN 3/4"	DIN-EN 853 3/4" Hidrolik Hortum
2 SN 1"	DIN-EN 853 1" Hidrolik Hortum
2 SN 1 1/4"	DIN-EN 853 1 1/4" Hidrolik Hortum
2 SN 1 1/2"	DIN-EN 853 1 1/2" Hidrolik Hortum
2 SN 2"	DIN-EN 853 2" Hidrolik Hortum

R9 4 KAT TELLİ HİDROLİK HORTUM

Kod	Özellik
4 SH 1/2"	Hidrolik Hortum
4 SH 5/8"	Hidrolik Hortum
4 SH 3/4"	Hidrolik Hortum
4 SH 1"	Hidrolik Hortum
4 SH 1 1/4"	Hidrolik Hortum
4 SH 1 1/2"	Hidrolik Hortum

WINMAN R6 HORTUM

Kod	Ölçü
R6	1/4"
R6	5/16"
R6	3/8"
R6	1/2"
R6	3/4"
R6	1"



WINMAN BEZLİ SARGILI HORTUM 10 BAR

Kod	Ölçü
1/2"	Bezli Sargılı Hortum 10 Bar
3/4"	Bezli Sargılı Hortum 10 Bar
1"	Bezli Sargılı Hortum 10 Bar
1 1/4"	Bezli Sargılı Hortum 10 Bar
1 1/2"	Bezli Sargılı Hortum 10 Bar
2"	Bezli Sargılı Hortum 10 Bar

FREWAY LOJİK VALFLER

YÖN KONTROL LOJİK KATRIÇLERİ

Kod	Max. Debi Lt./Dk.	Max. Basınç Bar	
LGD-16-B	200	350	
LGD-25-B	400	350	
LGD-50-B	2000	350	
LGD-63-B	3000	350	



BASINÇ LOJİK KATRIÇLERİ

Kod	Max. Debi Lt./Dk.	Max. Basınç Bar	
LGP-16-B	200	350	
LGP-25-B	400	350	



PLEYT TİPİ ÇEKVALF

Kod	Max. Debi Lt./Dk.	Max. Basınç Bar	
AJ-03	40	315	
AJ-06	100	315	
AJ-10	200	315	



KATRIÇ TİP EMNİYET

Kod	Ölçü	Max. Debi Lt./Dk.	Max. Basınç Bar	
LCY 10	M24x1,5	40	315	
LCY 15	M33x2	80	315	
LCY 20	M24x1,5	100	315	

FOX AKÜLER

HI SERİSİ DİYAFRAMLİ AKÜLER

Kod	Hacim Lt.	Max. Basınç Bar	Giriş Portu	
HI 350R	0,35	330	M18x1,5	
HI 500R	0,45	330	M18x1,5	
HI 700R	0,75	330	M18x1,5	
HI 990R	0,99	330	M18x1,5	
HI 1500R	1,5	330	M18x1,5	
HI 2200R	2,2	330	M18x1,5	
HI 2800R	2,8	330	M18x1,5	



HBR SERİSİ BALONLU AKÜLER

Kod	Hacim Lt.	Max. Basınç Bar	Giriş Portu	
HBR 4	4	350	1 1/4"	
HBR 6	6	350	1 1/4"	
HBR 10	10	350	1 1/4"	

FOX AKÜLER

H SERİSİ DİYAFRAMLİ AKÜLER

Kod	Hacim Lt.	Max.Basınç Bar	Giriş Portu
H150R	0,15	250	M18x1,5
H350R	0,35	250	M18x1,5
H500R	0,45	250	M18x1,5
H700R	0,70	250	M18x1,5
H1000R	1,00	250	M18x1,5
H1500R	1,50	250	M18x1,5
H2200R	2,20	250	M18x1,5
H4000R	3,80	210	3/4

HST SERİSİ DİYAFRAMLİ AKÜLER

Kod	Hacim Lt.	Max.Basınç Bar	Giriş Portu
HST 0,05	0,05	300	3/8" BSP
HST 0,12	0,12	300	M18x1,5
HST 0,35	0,35	300	M18x1,5
HST 0,5	0,50	300	M18x1,5
HST 0,7	0,70	300	M18x1,5
HST 0,8	0,80	300	M18x1,5
HST 1,3	1,30	300	M18x1,5
HST 1,5	1,50	300	M18x1,5
HST 2,3	2,30	300	M18x1,5

HB SERİSİ BALONLU AKÜLER

Kod	Hacim Lt.	Max.Basınç Bar	Giriş Portu
HB 2,5	2,50	350	1 1/4"
HB 4,5	4,50	350	1 1/4"
HB 6	6,00	350	1 1/4"
HB 10	10,00	350	1 1/4"
HB 20	18,50	350	2"
HB 25	25,00	350	2"
HB 50	49,00	350	2"

AKÜ AKSESUARLARI

Kod
AR 6 AKÜ DOLUM APARATI
SB2 AKÜ EMNİYET VALFİ
NS 15 AKÜ BAĞLANTI NİPELİ
NS 21 AKÜ BAĞLANTI NİPELİ

YEDEK AKÜ BALONU

Kod
2,5 Lt.
4 Lt.

VR SERİSİ AZOT VALFİ

Kod	Açıklama
VR	5/8" Unf Valf

FOX BASINÇ ŞALTERLERİ

Kod	Basınç Aralığı	Kontakt
K55 EP	20-200	NA NC
K57 EP	30-300	NA NC

FOX BASINÇ ŞALTERLERİ

Kod	Basınç Aralığı	Kontakt
KLV 54	0-100	NC NC
KLV 59	0-400	NC NC



FOX BASINÇ ŞALTERİ

K4 AYARLANABİLİR BASINÇ ŞALTERİ



Kod	Kontakt Açıklama	Bağlantı Ölçüsü	Basınç Aralığı (Bar)
K4SCF0/P1	NC	1/8" BSP	1-12
K4SCF0/P2	NO	1/8" BSP	1-12

F4 AYARLANABİLİR BASINÇ ŞALTERİ

Kod	Kontakt Açıklama	Bağlantı Ölçüsü	Basınç Aralığı (Bar)
F4SO/M3	NC-NO	1/8"	1-12
F4V1/M3	NC-NO	1/4"	10-100
F4Z1/M3	NC-NO	1/4"	20-200
F4Y1/M3	NC-NO	1/4"	50-400
F4T1/M3	NC-NO	1/4"	5,50

TR4 SERİSİ BASINÇ TRANSDUSERİ



Kod	Kontakt Açıklama	Bağlantı Ölçüsü	Basınç Aralığı (Bar)	Açıklama
TR 40,3/M3	0-10 V	1/4"	0-5	30x30 soket
TR 41,3/M3	0-10 V	1/4"	0-10	30x30 soket
TR 42,3/M2	0-10 V	1/4"	0-20	16x16 soket
TR 42,3/M3	0-10 V	1/4"	0-20	30x30 soket
TR 43,3/M3	0-10 V	1/4"	0-50	30x30 soket
TR 44,3/M3	0-10 V	1/4"	0-100	30x30 soket
TR 45,2/M3	4-20mA	1/4"	0-200	30x30 soket
TR 45,2/M12	4-20mA	1/4"	0-200	M12 pin
TR 49,2/M3	4-20mA	1/4"	0-400	30x30 soket
TR 49,2/M12	4-20mA	1/4"	0-400	M12 pin
TR 45,3/M3	0-10 V	1/4"	0-200	30x30 soket
TR 45,3/M12	0-10 V	1/4"	0-200	M12 pin
TR 49,3/M3	0-10 V	1/4"	0-400	30x30 soket
TR 49,3/M12	0-10 V	1/4"	0-400	M12 pin

FOX SEVİYE ŞALTERİ

LG1 SEVİYE ŞALTERİ



Kod	Kontakt Açıklama	Bağlantı Ölçüsü	Boy mm
LG1/300	NO	1"	300
LG1/400	NO	1"	400

LV SEVİYE GÖSTERGELİ ŞALTER



Kod	Kontakt Açıklama	Bağlantı Ölçüsü	Boy mm
LVSE 2	NC-NO	M12	127
LVSE 3	NC-NO	M12	254

HERMANN HİDROLİK SOLENOID VALFLER

NG 6 SOLENOID VALFLER

Kod	Açıklama	Max.Debi Lt./Dk.	Max.Basınç Bar	Voltaj
138869	Tek Bobinli H Geçişli	60	315	220
124402	Tek Bobinli H Geçişli	60	315	12
134269	Tek Bobinli H Geçişli	60	315	24
121933	Tek Bobinli K Geçişli	60	315	220
121606	Tek Bobinli K Geçişli	60	315	12
126066	Tek Bobinli K Geçişli	60	315	24
101588	T.B. H-A	60	315	220
114270	T.B. H-A	60	315	12
127503	T.B. H-A	60	315	24
127499	K.M.	60	315	220
134494	K.M.	60	315	12
127551	K.M.	60	315	24
136472	A.M.	60	315	220
138875	A.M.	60	315	12
134155	A.M.	60	315	24
136469	H.M.	60	315	220
136474	H.M.	60	315	12
136470	H.M.	60	315	24
112639	J.M.	60	315	220
124407	J.M.	60	315	12
124413	J.M.	60	315	24



NG 10 SOLENOID VALFLER

Kod	Açıklama	Max.Debi Lt./dk.	Max.Basınç Bar	Voltaj
101593	Tek Bobinli H Geçişli	120	315	220
132325	Tek Bobinli H Geçişli	120	315	24
134658	Tek Bobinli K Geçişli	120	315	220
137024	Tek Bobinli K Geçişli	120	315	24
114281	Tek Bobinli H-A	120	315	24
114283	Tek Bobinli H-A	120	315	220
145176	Tek Bobinli H-A	120	315	12
122100	K.M.	120	315	220
122850	K.M.	120	315	24
111882	A.M.	120	315	110
130473	A.M.	120	315	220
129113	H.M.	120	315	220
112339	H.M.	120	315	24
134870	J.M.	120	315	220
130542	J.M.	120	315	24



MODÜLER KİLİTLEME VALFLERİ

Kod	Açıklama	Max.Debi Lt./Dk.	Max.Basınç Bar
129536	NG 10	80	315

MODÜLER ÇEKİLİ HIZ AYAR VALFLERİ

Kod	Açıklama	Max.Debi Lt./Dk.	Max.Basınç Bar
128207	NG 6	80	315
101594	NG 10	160	315
101591	NG 16	250	315

HİDROLİK DEVRE BORULARI

FOSFAT KAPLI

Ölçü	
Ø 6x1	
Ø 8x1	
Ø 10x1,5	
Ø 12x1,5	
Ø 12x2	
Ø 15x1,5	
Ø 16x2	
Ø 18x1,5	
Ø 20x2	
Ø 22x2	
Ø 25x2,5	
Ø 25x3	
Ø 28x2	
Ø 30x3	
Ø 35x3	
Ø 42x4	

GALVANİZ KAPLI

Ölçü	
Ø 6x1	
Ø 8x1	
Ø 10x1,5	
Ø 12x1,5	
Ø 16x2	
Ø 20x2	

Not: Dikişsiz soğuk çekme, DIN 2391 / C St 37,4 NBK
Kalite sertifikası (EN 10204 / 3,1B'ye göre)
Marka: BENTELER
Boylar 6mt. olarak standarttır.
Fiyatlar net olarak hazırlanmıştır.
Stoklarla sınırlıdır.

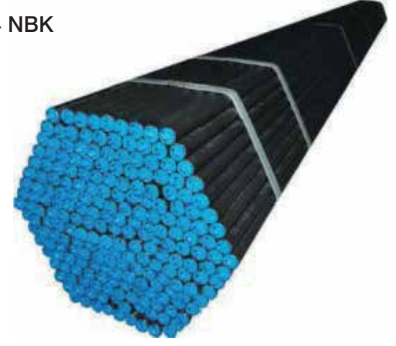

SIKIŞTIRILMIŞ DÖKÜM ÇUBUKLAR

GG 25 DÖKÜM MİLLER (DİKDÖRTGEN)

Ölçü	
▣ 60 x 90	
▣ 90 x 66	
▣ 100 x 80	
▣ 120 x 90	
▣ 130 x 90	
▣ 130 x 100	
▣ 165 x 135	

Kilogram fiyatlar yaklaşık olarak 3,68 Euro / kg.

GG 25 DÖKÜM MİLLER (YUVARLAK)

Ölçü	
Ø 50	
Ø 65	
Ø 70	
Ø 80	
Ø 85	
Ø 95	
Ø 105	
Ø 115	
Ø 120	
Ø 135	
Ø 140	
Ø 145	
Ø 150	
Ø 160	
Ø 180	
Ø 200	

Kilogram fiyatlar yaklaşık olarak 3,15 Euro / kg.

GGG DÖKÜM MİLLER (YUVARLAK)

Ölçü	GGG	
Ø 80	40	
Ø 90	40	
Ø 95	40	
Ø 100	40	
Ø 105	40	
Ø 140	50	
Ø 170	50	
Ø 190	50	



GGG DÖKÜM MİLLER (KARE)

Ölçü	GGG	
▣ 60x60	50	
▣ 100x100	40	
▣ 120x120	40	
▣ 160x160	40	

Kilogram fiyatlar yaklaşık olarak 4,62 Euro / kg.

GG 25 DÖKÜM MİLLER (KARE)

Ölçü	
▣ 60 x 60	
▣ 70 x 70	
▣ 80 x 80	
▣ 85 x 85	
▣ 100 x 100	
▣ 110 x 110	
▣ 150 x 150	
▣ 170 x 170	
▣ 200 x 200	

Kilogram fiyatlar yaklaşık olarak 3,47 Euro / kg.